

POOLEX

Vertigo **FI**

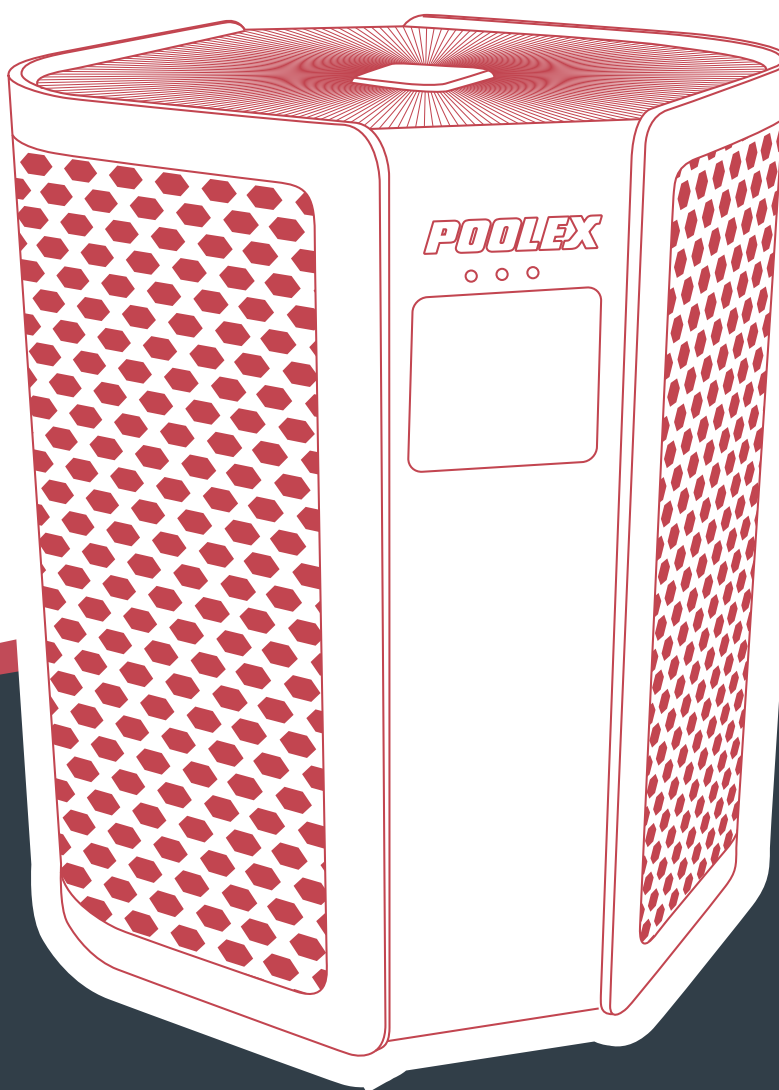

INSTALLATION AND USER MANUAL

for your heat pump

Warning



This heat pump contains a flammable refrigerant R32.

Any intervention on the refrigerant circuit is prohibited without a valid authorization.

Before working on the refrigerant circuit, the following precautions are necessary for safe work.

1. Work procedure

The work must be carried out according to a controlled procedure, in order to minimize the risk of presence of flammable gases or vapors during the execution of the works.

2. General work area

All persons in the area must be informed of the nature of the work in progress. Avoid working in a confined area. The area around the work area should be divided, secured and special attention should be paid to nearby sources of flame or heat.

3. Verification of the presence of refrigerant

The area should be checked with a suitable refrigerant detector before and during work to ensure that there is no potentially flammable gas. Make sure that the leak detection equipment used is suitable for flammable refrigerants, ie it does not produce sparks, is properly sealed or has internal safety.

4. Presence of fire extinguisher

If hot work is to be performed on the refrigeration equipment or any associated part, appropriate fire extinguishing equipment must be available. Install a dry powder or CO2 fire extinguisher near the work area.

5. No source of flame, heat or spark

It is totally forbidden to use a source of heat, flame or spark in the direct vicinity of one or more parts or pipes containing or having contained a flammable refrigerant. All sources of ignition, including smoking, must be sufficiently far from the place of installation, repair, removal and disposal, during which time a flammable refrigerant may be released into the surrounding area. Before starting work, the environment of the equipment should be checked to ensure that there is no risk of flammability. «No smoking» signs must be posted.

6. Ventilated area

Make sure the area is in the open air or is properly ventilated before working on the system or performing hot work. Some ventilation must be maintained during the duration of the work.

7. Controls of refrigeration equipment

When electrical components are replaced, they must be suitable for the intended purpose and the appropriate specifications. Only the parts of the manufacturer can be used. If in doubt, consult the technical service of the manufacturer.

The following controls should be applied to installations using flammable refrigerants:

- The size of the load is in accordance with the size of the room in which the rooms containing the refrigerant are installed;*
- Ventilation and air vents work properly and are not obstructed;*
- If an indirect refrigeration circuit is used, the secondary circuit must also be checked.*
- The marking on the equipment remains visible and legible. Illegible marks and signs must be corrected;*
- Refrigeration pipes or components are installed in a position where they are unlikely to be exposed to a substance that could corrode components containing refrigerant*

8. Verification of electrical appliances

Repair and maintenance of electrical components must include initial safety checks and component inspection procedures. If there is a defect that could compromise safety, no power supply should be connected to the circuit until the problem is resolved.

Initial security checks must include:

- That the capacitors are discharged: this must be done in a safe way to avoid the possibility of sparks;*
- No electrical components or wiring are exposed during loading, recovery or purging of the refrigerant gas system;*
- There is continuity of grounding.*

Thank you

Dear Customer,

Thank you for your purchase and for your confidence in our products.

These are the result of many years of research in the field of design and production of heat pumps for swimming pools. Our aim is to provide you with an exceptional high performance quality product.

We have produced this manual with the utmost care so that you get maximum benefit from your Poolex heat pump.

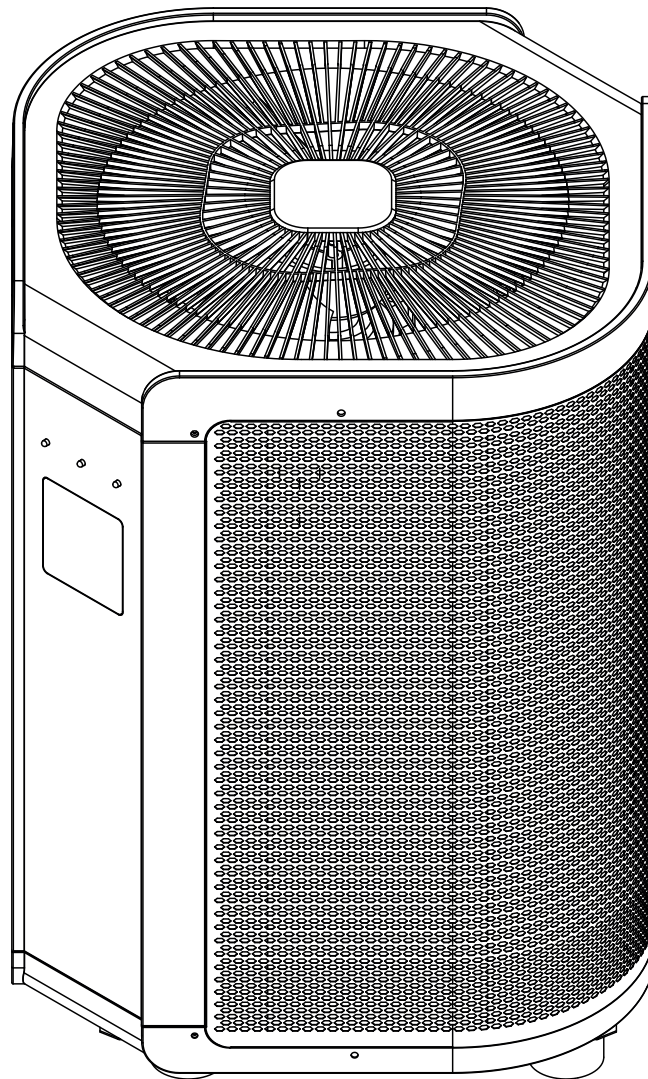



PLEASE READ CAREFULLY.



**These installation instructions are an integral part of the product.
They must be given to the installer and retained by the user.
If the manual is lost, please consult the website:**

www.poolex.fr

The instructions and recommendations contained in this manual should be read carefully and understood since they provide valuable information concerning the heat pump's safe handling and operation. **Keep this manual in an accessible place for easy future reference.**

Installation must be carried out by a qualified professional person in accordance with current regulations and the manufacturer's instructions. An installation error may cause physical injury to persons or animals as well as mechanical damage for which the manufacturer can under no circumstances be held responsible.

After unpacking the heat pump, please check the contents in order to report any damage.

Prior to connecting the heat pump, ensure that the information provided in this manual is compatible with the actual installation conditions and does not exceed the maximum limits authorised for this particular product.

In the event of a defect and/or malfunction of the heat pump, the electricity supply must be disconnected and no attempt made to repair the fault.

Repairs must be undertaken only by an authorised technical service organisation using original replacement parts. Failure to comply with the above-mentioned clauses may have an adverse effect on the heat pump's safe operation.

To guarantee the heat pump's efficiency and satisfactory operation, it is important to ensure its regular maintenance in accordance with the instructions provided.

If the heat pump is sold or transferred, always make sure that all technical documentation is transmitted with the equipment to the new owner.

This heat pump is designed solely for heating a swimming pool. Any other use must be considered as being inappropriate, incorrect or even hazardous.

Any contractual or non-contractual liability of the manufacturer/distributor shall be deemed null and void for damage caused by installation or operational errors, or due to non-compliance with the instructions provided in this manual or with current installation norms applicable to the equipment covered by this document.

Contents

1.	General	6
1.1	General Terms of Delivery	6
1.2	Safety instructions	6
1.3	Water treatment	7
2.	Description	8
2.1	Package contents	8
2.2	General characteristics	8
2.3	Technical specifications	9
2.4	Unit dimensions	10
2.5	Exploded view	11
3.	Installation	12
3.1	Pre-requirements	12
3.2	Location	12
3.3	Installation layout	13
3.4	Connecting the condensation draining kit	13
3.5	Installing the unit on noise-damping supports	13
3.6	Hydraulic connection	14
3.7	Electrical installation	16
3.8	Electrical connection	17
4.	Use	18
4.1	Remote control	18
4.2	Operating mode selector	19
4.3	Setting the clock	20
4.4	Programming Start/Stop	20
4.5	Activating / Deactivating a program	20
4.6	Forced de-icing function	21
4.7	Activating / Deactivating LED	21
4.8	Downloading & Installing the «Smart Life» app	22
4.9	Setting up the app	23
4.10	Pairing the heat pump	25
4.10.1	EZ Mode	25
4.11	Controlling	26
4.12	Status values	28
4.13	System parameter query	29
5.	Operation	31
5.1	Operation	31
5.2	Servo-control of circulating pump	31
5.3	Using the pressure gauge	32
5.4	Antifreeze protection	32
6.	Maintenance and servicing	33
6.1	Maintenance and servicing	33
6.2	Winter storage	33
7.	Repairs	34
7.1	Breakdowns and faults	34
7.2	Winter storage	35
8.	Recycling	36
8.1	Recycling the heat pump	36
9.	Warranty	37
9.1	General warranty conditions	37
10.	Appendices	38
10.1	Wiring diagrams	38
10.2	Errors 20	43

1. General

1.1 General Terms of Delivery

All equipment, even if shipped 'free of carriage and packing', is dispatched at the consignee's own risk

The person responsible for receiving the equipment must carry out a visual inspection to identify any damage to the heat pump during transport (refrigerant system, body panels, electrical control box, frame). He/she must note down on the carrier's delivery note any remarks concerning damage caused during transport and confirm them to the carrier by registered letter within 48 hours.

The equipment must always be stored and transported vertically on a pallet and in its original packaging. If



it is stored or transported horizontally, wait at least 24 hours before switching it on.

1.2 Safety instructions



WARNING: Please read carefully the safety instructions before using the equipment. The following instructions are essential for safety so please strictly comply with them.

During installation and servicing

Only a qualified person may undertake installation, start-up, servicing and repairs, in compliance with current standards.

Before operating or undertaking any work on the equipment (installation, commissioning, usage, servicing), the person responsible must be aware of all the instructions in the heat pump's installation manual as well as the technical specifications.

Under no circumstances install the equipment close to a source of heat, combustible materials or a building's air intake.

If installation is not in a location with restricted access, a heat pump protective grille must be fitted.

To avoid severe burns, do not walk on pipework during installation, repairs or maintenance.

To avoid severe burns, prior to any work on the refrigerant system, turn off the heat pump and wait several minutes before placing temperature and pressure sensors.

Check the refrigerant level when servicing the heat pump.

Check that the high and low pressure switches are correctly connected to the refrigerant system and that they turn off the electrical circuit if tripped during the equipment's annual leakage inspection.

Check that there is no trace of corrosion or oil stains around the refrigerant components.

1. General

During use

To avoid serious injuries, never touch the fan when it is operating.

Keep the heat pump out of the reach of children to avoid serious injuries caused by the heat exchanger's blades.

Never start the equipment if there is no water in the pool or if the circulating pump is stopped.

Check the water flow rate every month and clean the filter if necessary.

During cleaning

Switch off the equipment's electricity supply.

Close the water inlet and outlet valves.

Do not insert anything into the air or water intakes or outlets.

Do not rinse the equipment with HP water.

During repairs

Carry out work on the refrigerant system in accordance with current safety regulations.

Brazing should be performed by a qualified welder.

When replacing a defective refrigerant component, use only parts certified by our technical department.

In case of piping replacement, only copper tubing conforming to country standards may be used for troubleshooting.

When pressure-testing to detect leaks:

To avoid the risks of fire or explosion, never use oxygen or dry air.

Use dehydrated nitrogen or a mixture of nitrogen and refrigerant.

The low and high side test pressure must not exceed 42 bar.

1.3 Water treatment

Poolex heat pumps for swimming pools can be used with all types of water treatment systems.

Nevertheless, it is essential that the treatment system (chlorine, pH, bromine and/or salt chlorinator metering pumps) is installed after the heat pump in the hydraulic circuit.

To avoid any deterioration to the heat pump, the water's pH must be maintained between 6.9 and 8.0.

2. Description

2.1 Package contents

- ✓ Heat pump Poolex Vertigo Fi
- ✓ 2 hydraulic inlet/outlet connectors (50mm diameter)
- ✓ This installation and user manual
- ✓ Condensation draining kit
- ✓ **Winter storage cover**
- ✓ **4 anti-vibration pads (fastenings not supplied)**

2.2 General characteristics

A Poolex heat pump has the following features:

- ◆ CE certification and complies with the RoHS European directive.
- ◆ High performance with up to 80% energy savings compared to a conventional heating system.
- ◆ Clean, efficient and environmentally friendly R32 refrigerant.
- ◆ Reliable high output leading brand compressor.
- ◆ Wide hydrophilic aluminium evaporator for use at low temperatures.
- ◆ User-friendly intuitive remote control.
- ◆ Heavy duty ABS shell, anti-UV treated and easy to maintain.
- ◆ Designed to be silent.
- ◆ Dual antifreeze system to avoid frost damage:
 - Revolutionary exchanger with patented antifreeze system.
 - A smart monitoring system to preserve the pipework and liner without emptying the pool in winter.

2. Description

2.3 Technical specifications

		Poolex Vertigo FI											
Test conditions		55	75	95	125	155	200	240	155T	200T	240T	300T	350T
Air ⁽¹⁾ 26°C Water ⁽²⁾ 26°C INVERTER MODE	Heating power (kW)	7.70~1.50	10.35~1.98	13.27~2.53	16.53~3.16	21.2~4.05	26.82~5.17	32.63~6.31	21.2~4.05	26.86~5.17	32.66~6.31	40.3~7.79	45.65~8.79
	Consumption (kW)	1.12~0.098	1.50~0.129	1.93~0.167	2.38~0.206	3.09~0.267	4.17~0.348	4.82~0.412	3.09~0.266	4.16~0.347	4.81~0.411	5.97~0.507	6.88~0.577
	COP (Coeff. of performance)	15.31~6.84	15.35~6.87	15.15~6.84	15.34~6.93	15.17~6.86	14.86~6.43	15.32~6.76	15.23~6.86	14.90~6.44	15.35~6.78	15.36~6.75	15.23~6.63
Air ⁽¹⁾ 26°C Water ⁽²⁾ 26°C SILENCE MODE	Heating power (kW)	4.71~1.50	6.38~1.98	7.98~2.53	10.32~3.16	13.11~4.05	16.59~5.17	20.34~6.31	13.11~4.05	16.59~5.17	20.34~6.31	25.39~7.79	29.15~8.79
	Consumption (kW)	0.66~0.098	0.88~0.129	1.10~0.167	1.42~0.206	1.81~0.267	2.25~0.348	2.83~0.412	1.81~0.266	2.25~0.347	2.82~0.411	3.57~0.507	4.10~0.577
	COP (Coeff. of performance)	15.31~7.14	15.35~7.25	15.15~7.25	15.34~7.25	15.17~7.24	14.86~7.33	15.32~7.17	15.23~7.24	14.90~7.33	15.35~7.20	15.36~7.09	15.23~7.10
Air ⁽¹⁾ 15°C Water ⁽²⁾ 26°C INVERTER MODE	Heating power (kW)	5.82~1.15	7.82~1.52	9.83~2.01	12.62~2.43	15.83~3.15	20.03~4.15	24.22~5.38	15.83~3.15	20.06~4.15	24.24~5.35	30.06~6.31	35.02~7.33
	Consumption (kW)	1.18~0.153	1.58~0.20	2.00~0.264	2.60~0.323	3.28~0.418	4.42~0.565	5.00~0.715	3.28~0.417	4.41~0.564	4.99~0.709	6.24~0.839	7.40~0.980
	COP (Coeff. of performance)	7.52~4.93	7.60~4.95	7.61~4.92	7.52~4.85	7.54~4.82	7.35~4.52	7.52~4.84	7.55~4.82	7.36~4.54	7.55~4.85	7.52~4.81	7.48~4.73
Air ⁽¹⁾ 15°C Water ⁽²⁾ 26°C SILENCE MODE	Heating power (kW)	3.83~1.15	5.11~1.52	6.43~2.01	8.03~2.43	10.85~3.15	13.07~4.15	15.68~5.38	10.85~3.15	13.17~4.15	15.62~5.35	19.57~6.31	22.03~7.33
	Consumption (kW)	0.72~0.153	0.94~0.20	1.21~0.264	1.51~0.323	2.03~0.418	2.43~0.565	2.95~0.715	2.03~0.417	2.45~0.564	2.93~0.709	3.73~0.839	4.21~0.980
	COP (Coeff. of performance)	7.52~5.32	7.60~5.44	7.61~5.31	7.52~5.32	7.54~5.32	7.35~5.35	7.52~5.29	7.55~5.32	7.36~5.35	7.55~5.32	7.52~5.23	7.48~5.23
Air ⁽¹⁾ 35°C Water ⁽²⁾ 27°C	Cooling capacity (kW)	3.78~1.25	5.08~1.69	6.39~2.13	8.20~2.70	10.29~3.39	13.04~4.32	15.76~5.24	10.29~3.39	13.04~4.32	15.76~5.24	19.54~6.51	22.76~7.36
	Consumption (kW)	1.09~0.263	1.46~0.355	1.85~0.445	2.40~0.57	3.01~0.713	4.09~0.909	4.62~1.10	3.01~0.710	4.08~0.908	4.60~1.10	5.76~1.36	6.82~1.56
	Avg. EER (Energy Efficiency Ratio)	4.75~3.47	4.76~3.48	4.79~3.45	4.74~3.42	4.75~3.39	4.75~3.18	4.76~3.40	4.77~3.39	4.76~3.19	4.76~3.41	4.79~3.39	4.72~3.33
Maximum power (kW)	1,6	2	2,8	3,3	4,8	5,8	6,5	4,8	5,8	6,5	8,2	9	
Maximum current (A)	7,10	8,87	12,42	14,64	21,30	25,73	28,84	8,58	10,37	11,62	14,66	16,09	
Electricity supply	220~240V / 50Hz							380~415V / 50Hz					
Protection	IPX4												
Heating temperature range	15°C~40°C												
Cooling temperature range	8°C~28°C												
Operating temperature range	-10°C~43°C												
Unit dimensions L x W x H (mm)	510*510*690				575*575*780			660*660*1030	575*575*780		680*680*1100		
Unit weight (kg)	30	35	40	47	52	100	104	52	104	104	120	120	
Sound pressure level at 1 m (dBA) ⁽³⁾	36~45	38~46	38~46	41~50	42~52	47~56	48~57	42~52	48~57	48~57	49~59	49~59	
Sound pressure level at 10 m (dBA) ⁽³⁾	19~27	20~28	20~28	23~31	24~32	28~37	29~38	24~32	29~38	29~38	30~39	30~39	
Hydraulic connection (mm)	PVC 50mm												
Heat exchanger	Cuve PVC et Serpentin Titane												
Min. / Max. water flow rate (m³/h)	2,4	3,2	4	5	6,7	8,5	10,5	6,7	8,5	10,5	13,0	15,0	
Compressor	GMCC	GMCC	GMCC	GMCC	GMCC	GMCC	GMCC	GMCC	GMCC	GMCC	GMCC	GMCC	GMCC
Compressor type	Single-Rotary			TWIN-ROTARY									
Refrigerant	R32												
Load loss (mCE)	1,1												
Max. pool volume (m³) ⁽⁴⁾	30-45	40-55	50-70	70-90	80-115	110~140	140-170	80-115	110~140	140-170	170-210	210-250	
Remote control	Fixed touch screen control												
Mode	Heating / Cooling / Silent												

The technical specifications of our heat pumps are provided for information purposes only. We reserve the right to make changes without prior notice.

¹ Ambient air temperature

² Initial water temperature

³ Noise at 1 m, at 4 m and at 10 m in accordance with Directives EN ISO 3741 and EN ISO 354

⁴ Calculated for an in-ground private swimming pool covered with a bubble cover.

2. Description

2.4 Unit dimensions

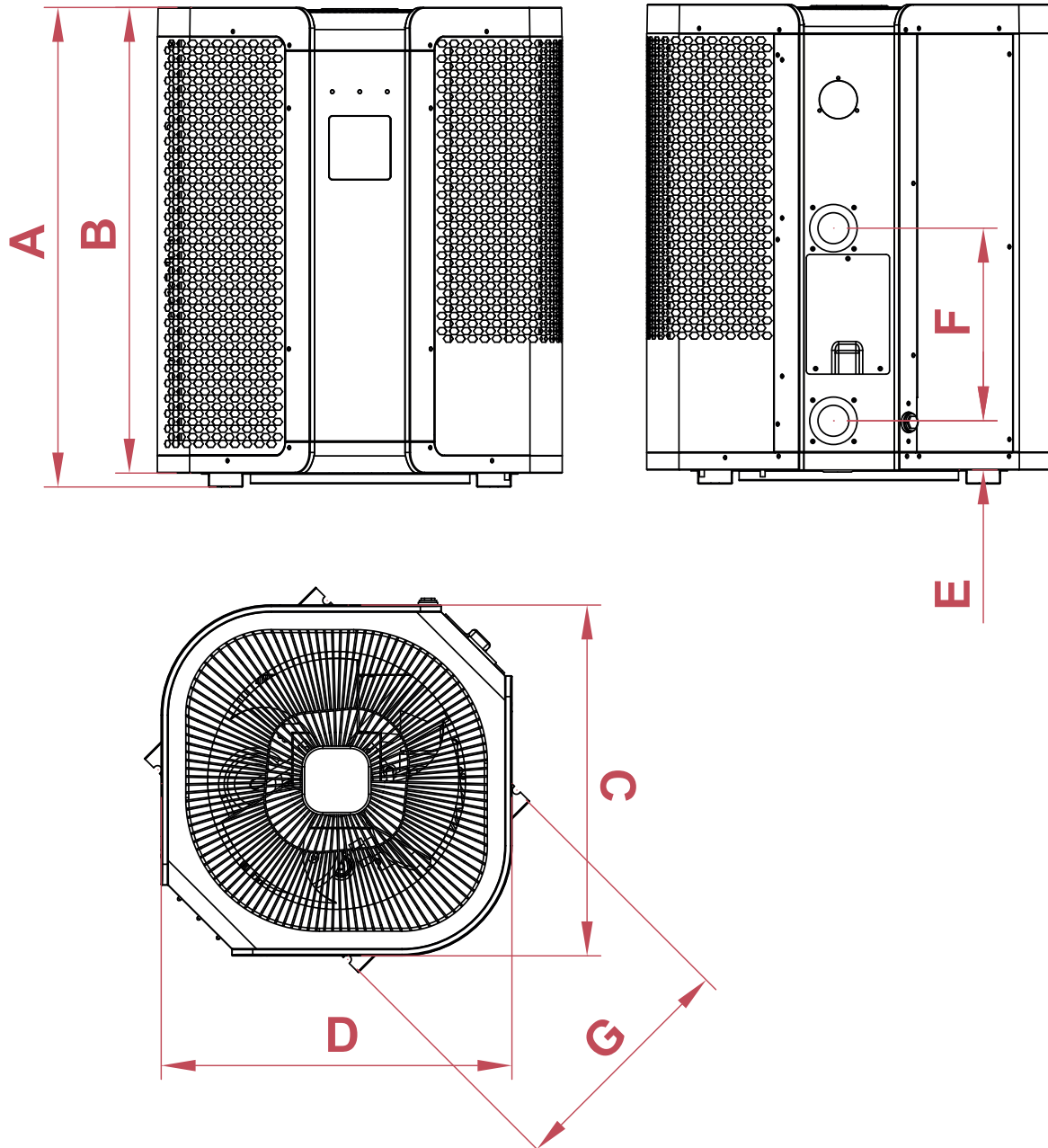

dimensions en mm

Model	55 / 75 / 95	125 / 155 / 200 / 200T	240 / 240T / 300T	350
A	697	790	1077	1098
B	677	770	1057	1066.5
C	510	575	680	680
D	510	575	680	680
E	71.2	82.5	81.2	81.2
F	280	380	520	350
G	348	435	500	500

2. Description

2.5 Exploded view

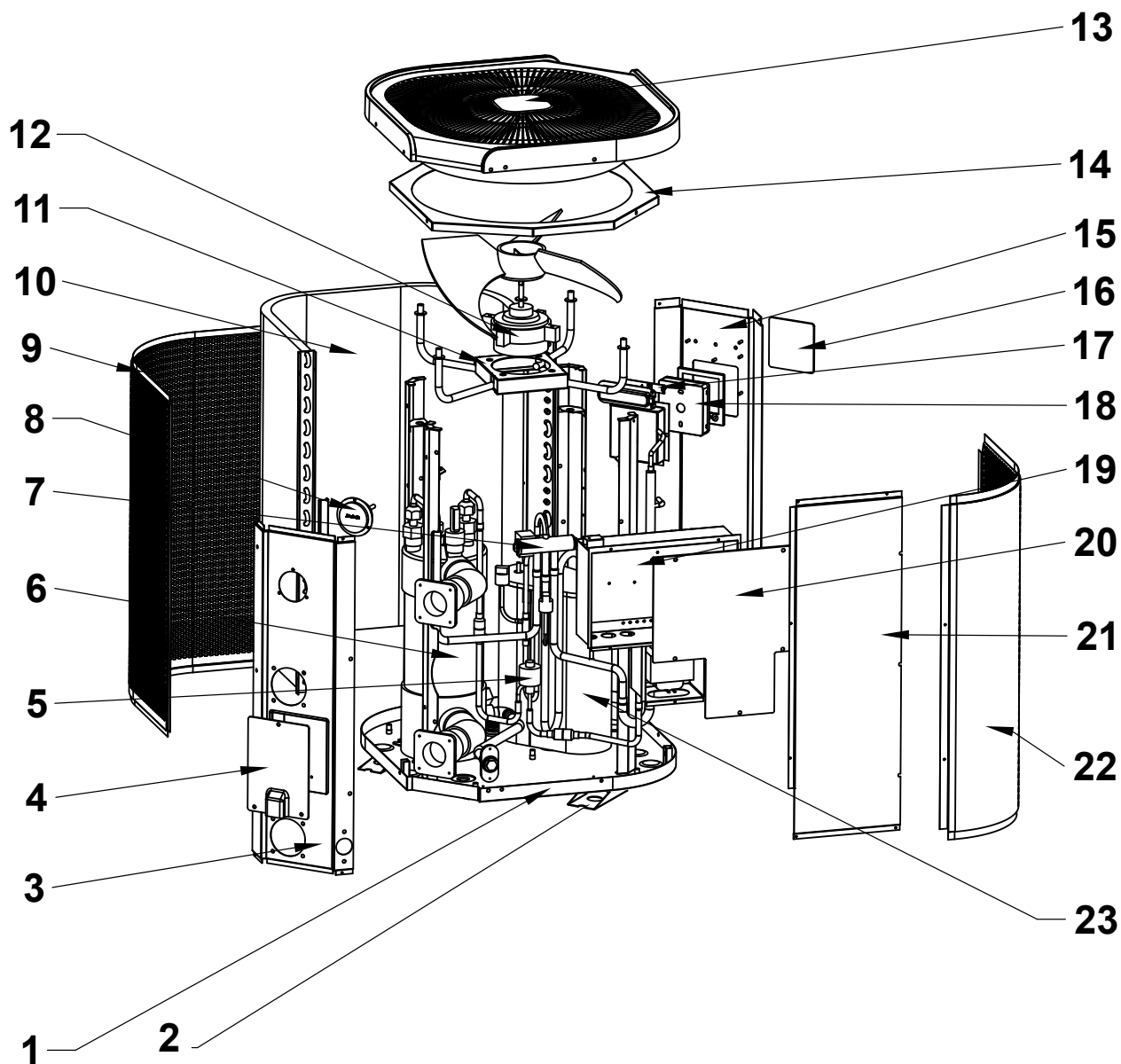

- | | |
|-------------------------------|----------------------------|
| 1. Base frame | 13. Top panel |
| 2. Support | 14. Top frame |
| 3. Left side panel | 15. Front panel |
| 4. Electrical terminal block | 16. controller glass film |
| 5. Electronic expansion valve | 17. LED indicator |
| 6. Heat exchanger | 18. Control panel |
| 7. 4-way valve | 19. Electrical control box |
| 8. Pressure gauge | 20. Electrical box cover |
| 9. Left side grill | 21. Right side panel |
| 10. Evaporator | 22. Right side grill |
| 11. Fan support | 23. Compressor |
| 12. Fan motor | |

3. Installation



WARNING: Installation must be carried out by a qualified engineer.

This section is provided for information purposes only and must be checked and adapted if necessary according to the actual installation conditions.

3.1 Pre-requirements

Equipment necessary for the installation of your heat pump:

Power supply cable suitable for the unit's power requirements.

A *By-Pass* kit and an assembly of PVC tubing suitable for your installation as well as stripper, PVC adhesive and sandpaper.

A set of wall plugs and expansion screws suitable to attach the unit to your support.

We recommend that you connect the unit to your installation by means of flexible PVC pipes in order to reduce the transmission of vibrations.

Suitable fastening studs may be used to raise the unit.

3.2 Location

Please comply with the following rules concerning the choice of heat pump location.

1. The unit's future location must be easily accessible for convenient operation and maintenance.
2. It must be installed on the ground, fixed ideally on a level concrete floor. Ensure that the floor is sufficiently stable and can support the weight of the unit.
3. A water drainage device must be provided close to the unit in order to protect the area where it is installed.
4. If necessary, the unit may be raised by using suitable mounting pads designed to support its weight.
5. Check that the unit is properly ventilated, that the air outlet is not facing the windows of neighbouring buildings and that the exhaust air cannot return. In addition, provide sufficient space around the unit for servicing and maintenance operations.
6. The unit must not be installed in an area exposed to oil, flammable gases, corrosive products, sulphurous compounds or close to high frequency equipment.
7. To prevent mud splashes, do not install the unit near a road or track.
8. To avoid causing nuisance to neighbours, make sure the unit is installed so that it is positioned towards the area that is least sensitive to noise.
9. Keep the unit as much as possible out of the reach of children.

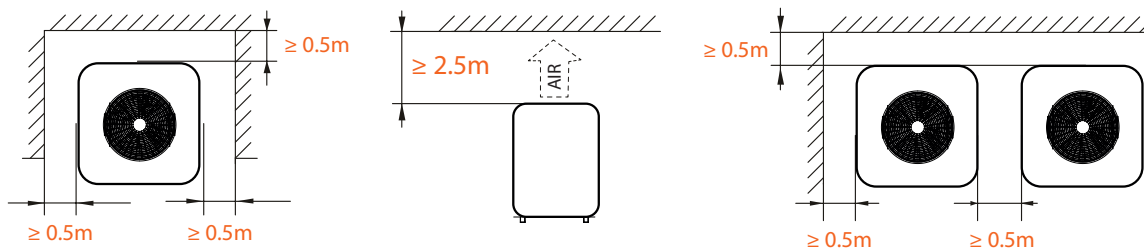

Dimensions in mm.

Place nothing less than one metre in front of the heat pump.
Leave 50 cm of empty space around the sides and rear of the heat pump.

Do not leave any obstacle above or in front of the unit!

3. Installation

3.3 Installation layout

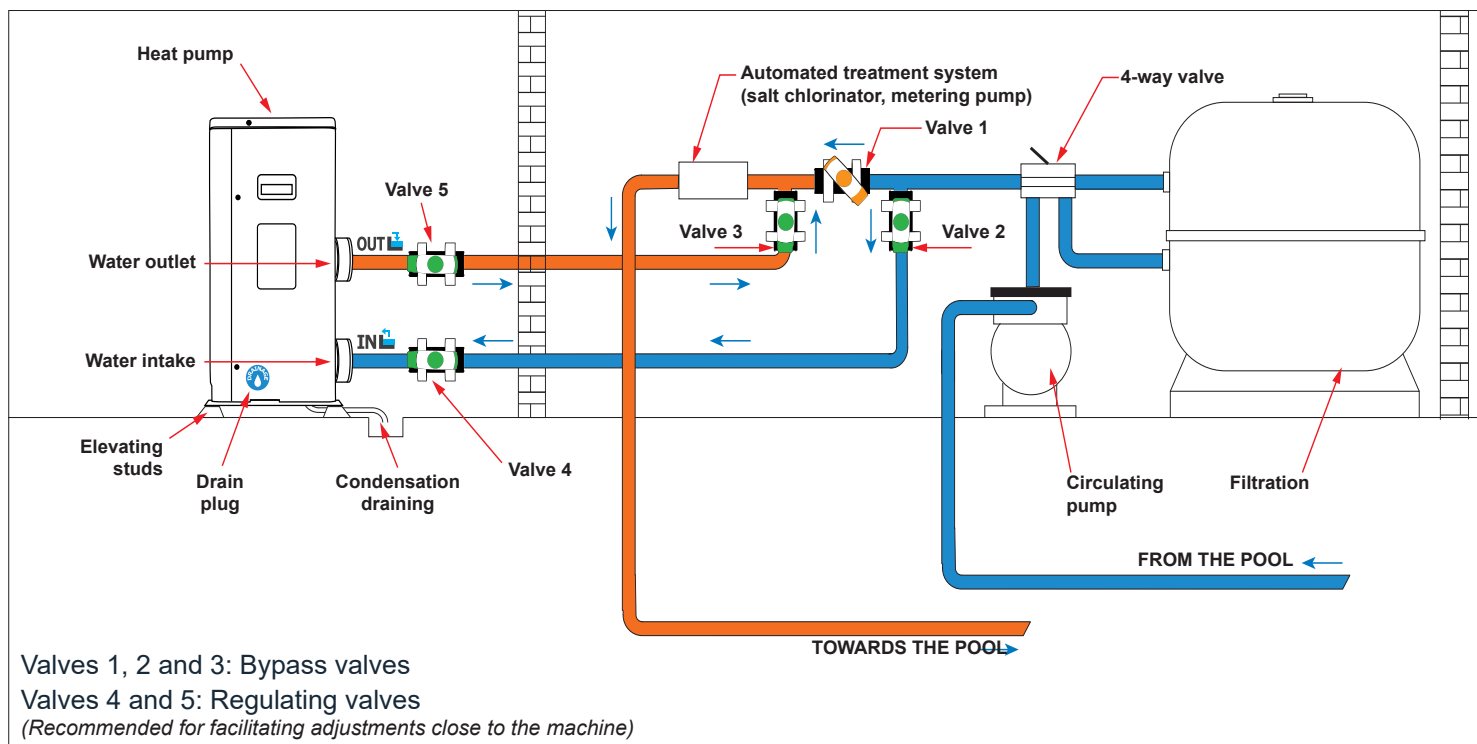

3.4 Connecting the condensation draining kit

While operating, the heat pump is subject to condensation. This will result in a more or less large run-off of water, depending on the degree of humidity. To channel this flow, we recommend that you install the condensation drainage kit.

How do you install the condensation drainage kit?

Install the heat pump, raising it at least 10 cm with solid water-resistant pads, then connect the drainage pipe to the opening located under the pump.

3.5 Installing the unit on noise-damping supports

In order to minimise the noise pollution associated with heat pump vibrations, it can be positioned on vibration absorbing pads.

To do this, you simply have to position a pad between each of the unit's feet and its support, and then fix the heat pump to the support with suitable screws.

3. Installation



WARNING: Installation must be carried out by a qualified engineer.

This section is provided for information purposes only and must be checked and adapted if necessary according to the actual installation conditions.

3.6 Hydraulic connection

By-Pass assembly

The heat pump must be connected to the pool by means of a By-Pass assembly.

A By-Pass is an assembly consisting of 3 valves that regulate the flow circulating in the heat pump. During maintenance operations, the By-Pass permits the heat pump to be isolated from the system without interrupting your installation.

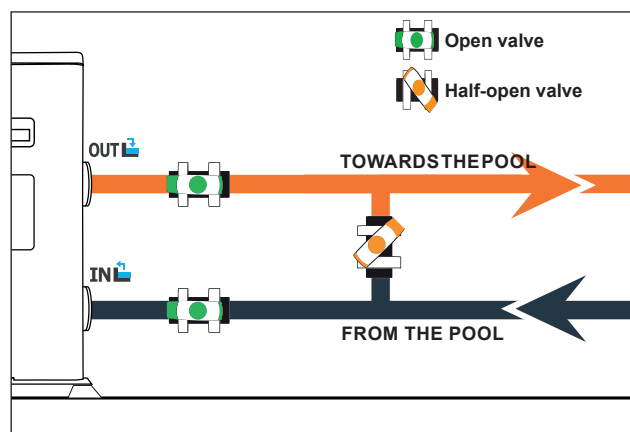

Making a hydraulic connection with the By-Pass kit



WARNING: Do not run water through the hydraulic circuit for 2 hours after applying the adhesive.

Step 1: Take the necessary steps to cut your pipes.

Step 2: Make a straight perpendicular cut through the PVC pipes with a saw.

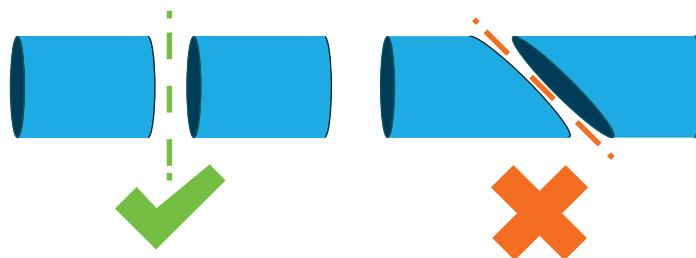

Step 3: Assemble your hydraulic circuit without connecting it in order to check that it perfectly fits your installation, then dismantle the pipes to be connected.

Step 4: Chamfer the ends of the cut pipes with sandpaper.

Step 5: Apply stripper to the ends of the pipes to be connected.

Step 6: Apply the adhesive in the same place.

Step 7: Assemble the pipes.

Step 7: Clean off any adhesive remaining on the PVC.

Step 8: Leave to dry for at least 2 hours before putting the hydraulic circuit into water.

3. Installation

By-Pass assembly for one heat pump

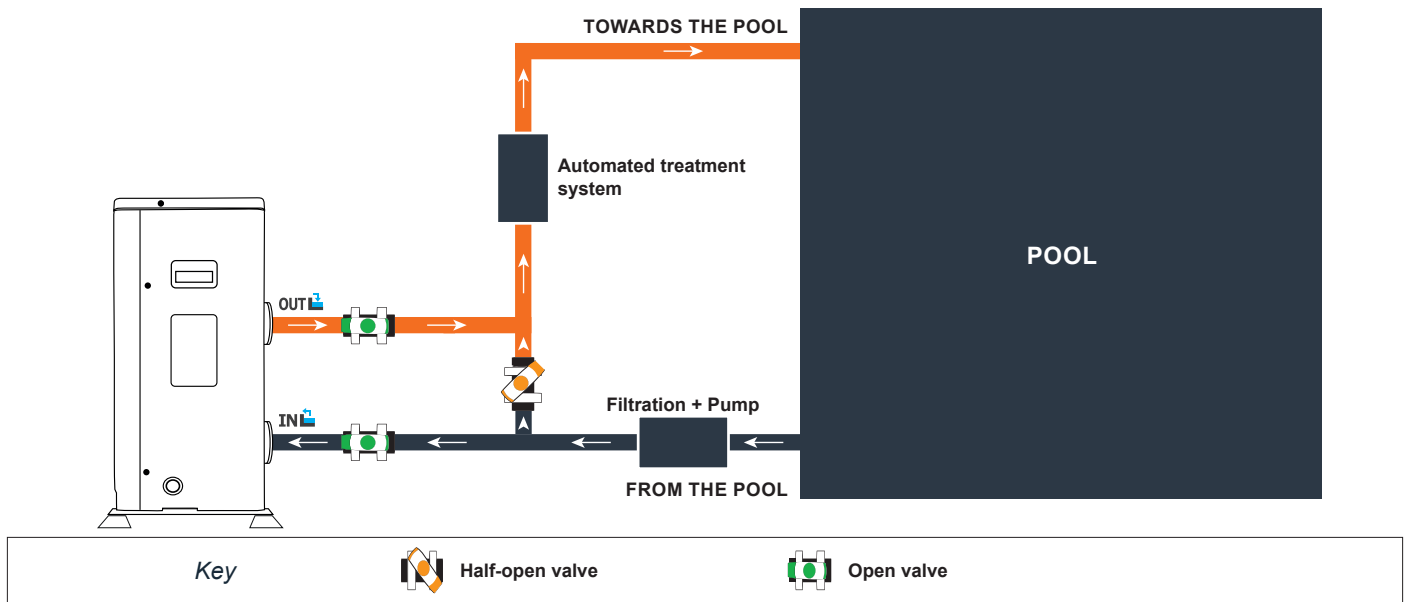

By-Pass assembly for more than one heat pump

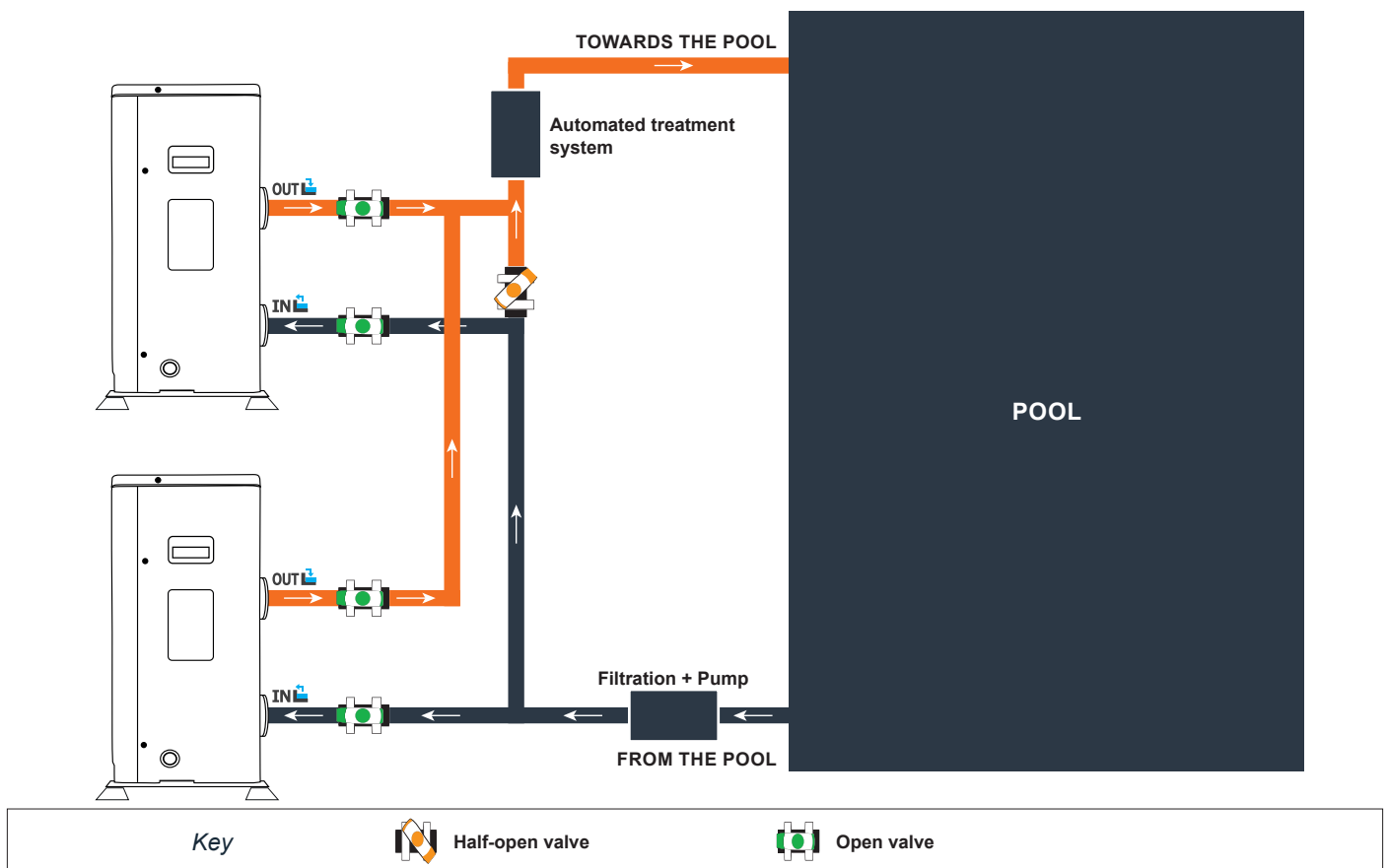

The filter located upstream of the heat pump must be regularly cleared so that the water in the system is clean, thus avoiding the operational problems associated with dirt or clogging in the filter.

3. Installation



WARNING: Installation must be carried out by a qualified engineer.

This section is provided for information purposes only and must be checked and adapted if necessary according to the actual installation conditions.

3.7 Electrical installation

To function safely and maintain the integrity of your electrical system, the unit must be connected to a general electricity supply in accordance with the following regulations:

Upstream, the general electricity supply must be protected by a 30 mA differential switch.

The heat pump must be connected to a suitable D-curve circuit breaker (see table below) in accordance with current standards and regulations in the country where the system is installed.

The electricity supply cable must be adapted to match the unit's rated power and the length of wiring required by the installation (see table below). The cable must be suitable for outdoor use.

For a three-phase system, it is essential to connect the phases in the correct sequence. If the phases are inverted, the heat pump's compressor will not work.

In places open to the public, it is mandatory to install an emergency stop button close to the heat pump.

Models	Electricity supply	Max. current	Cable diameter	Protection Thermal-magnetic (D curve) protection
Poolex Vertigo Fi 55	Singlephase 230V~50Hz	7.1A	RO2V 3x2.5 mm ²	10A
Poolex Vertigo Fi 75		8.87A	RO2V 3x2.5 mm ²	10A
Poolex Vertigo Fi 95		12.42A	RO2V 3x4 mm ²	16A
Poolex Vertigo Fi 125		14.64A	RO2V 3x4 mm ²	16A
Poolex Vertigo Fi 155		21.30A	RO2V 3x6 mm ²	25A
Poolex Vertigo Fi 200		25.73A	RO2V 3x10 mm ²	32A
Poolex Vertigo Fi 240		28.84A	RO2V 3x10 mm ²	32A
Poolex Vertigo Fi 155T	triplephase 380-415V/3N~50Hz	8.58A	RO2V 5x2.5 mm ²	10A
Poolex Vertigo Fi 200T		10.37A	RO2V 5x2.5 mm ²	16A
Poolex Vertigo Fi 240T		11.62A	RO2V 5x2.5 mm ²	16A
Poolex Vertigo Fi 300T		14.66A	RO2V 5x2.5 mm ²	16A
Poolex Vertigo Fi 350T		16.09A	RO2V 5x2.5 mm ²	20A

¹ Cable cross-section suitable for max. length 10 metres. For longer than 10 metres, consult an electrician.

3. Installation

3.8 Electrical connection



WARNING: The heat pump's power supply **MUST** be disconnected before any operation.

Please comply with the following instructions to electrically connect the heat pump.

Step 1: Detach the electrical side panel with a screwdriver to access the electrical terminal block.

Step 2: Insert the cable into the heat pump unit by passing it through the opening provided for that purpose.

Step 3: Connect the power supply cable to the terminal block in accordance with the diagram below.

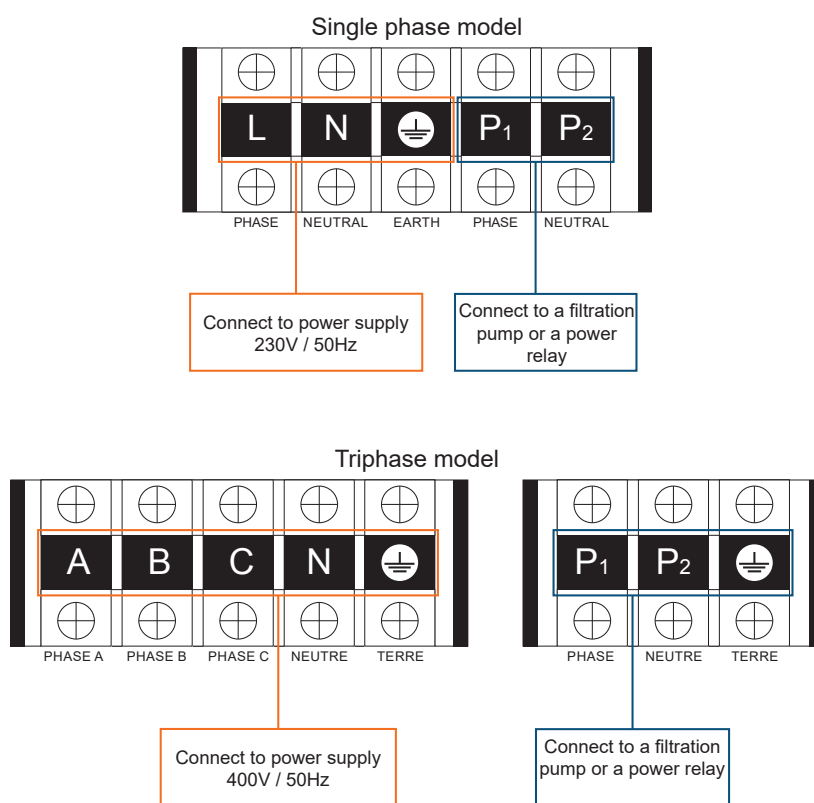

Step 4: Carefully close the heat pump panel.

Servo-control of circulating pump

Depending on the type of installation, you can also connect a circulating pump to terminals P1 and P2 so that this operates in tandem with the heat pump.



WARNING: Servo-control of a pump whose power exceeds 5A (1000W) requires the use of a power relay.

4. Use

4.1 Wired remote control

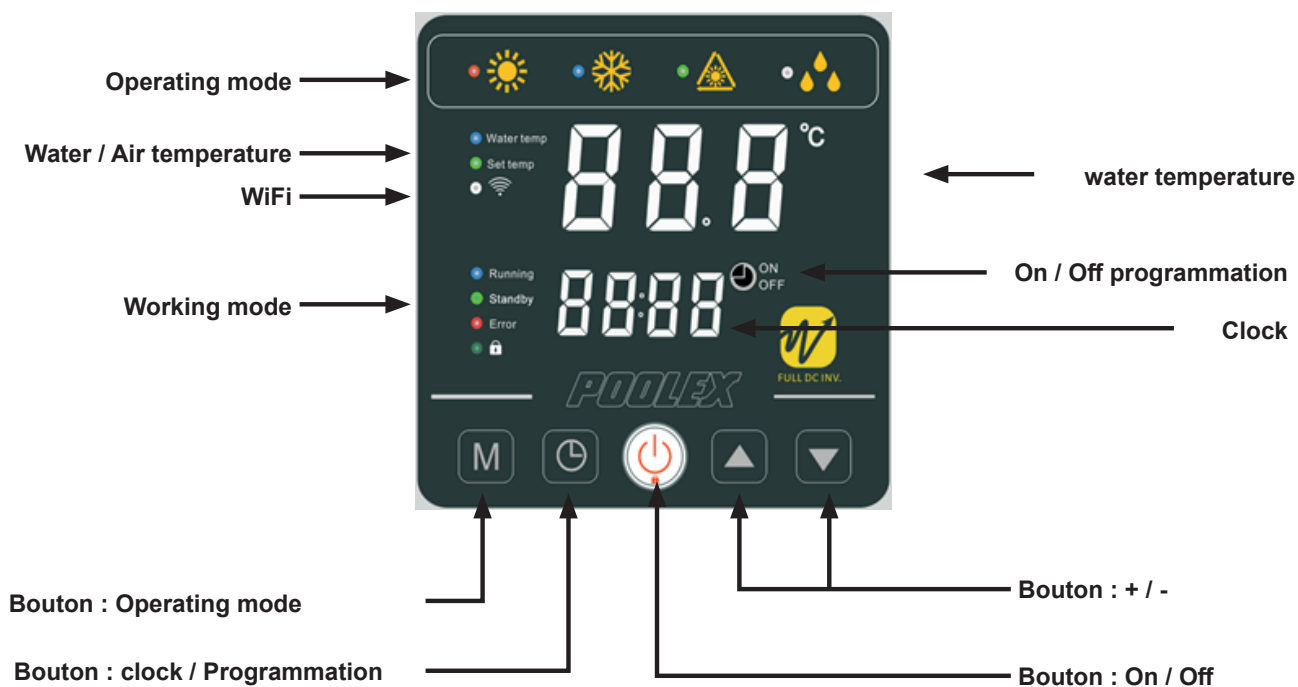

Locking the control panel

To lock or unlock the control panel, press 3s the buttons  and 

Start the heat pump

To start the heat pump, press the  button for 3s

Adjusting the water temperature

Once the unit is unlocked, press the  or  buttons to set the desired temperature.

4. Use

4.2 Operating mode selector



Before starting, ensure that the filtration pump is working and that water is circulating through the heat pump.

To choose the operating mode, press the **M** button for 3s



SILENT Heating mode: Choose this heating mode so that the heat pump operates silently.



ECO Heating mode: Choose this heating mode for the heat pump to operate in a conventional manner.



BOOST heating mode: Choose this heating mode so that the heat pump quickly heats the water in your pool.



Auto mode: The heat pump intelligently chooses the most appropriate operating mode according to the setpoint temperature.



SILENT Cooling mode: Choose this cooling mode for the heat pump to operate silently.



ECO Cooling mode: Choose this cooling mode so that the heat pump operates in a conventional manner.



BOOST Cooling mode: Choose this cooling mode for the heat pump to operate in a classic way.

Useful information









WARNING: When the cooling mode switches to heating mode or vice-versa, the heat pump will restart after 10 minutes.

When the incoming water temperature is less than or equal to the required temperature (setpoint temperature - 1°C), the heat pump will switch to heating mode. The compressor will stop when the temperature of the incoming water is greater than or equal to the required temperature (setpoint temperature + 1°C).

4. Use

4.3 Setting the clock

















Set the system clock to local time, as follows:

- Step 1:** Press  to set the time, the hours are blinking.
- Step 2:** Adjust the hours with the buttons  and .
- Step 3:** Press  to switch to minutes.
- Step 4:** Adjust the minutes with the buttons  and .
- Step 5:** Press  to validate and return to the main screen.



4.4 Programming Start/Stop





This function is for programming the Start/Stop timing. You can programme up to 3 different Start/Stop timings. Setting is as follows:

- Step 1:** Long press  3s to enter into timer functions
- Step 2:** Select the programme to be configured with the buttons  and .
- Step 3:** Press  to programme the start time.
- Step 4:** Adjust the hours with the buttons  and .
- Step 5:** Press  to switch to minutes.
- Step 6:** Adjust the minutes with the buttons  and .
- Step 7:** Press  to programme the stop time.
- Step 8:** Adjust the hours with the buttons  and .
- Step 9:** Press  to switch to minutes.
- Step 10:** Adjust the minutes with the buttons  and .
- Step 11:** Press  to return to the main screen.

NB: The remote control returns automatically to the main screen after 10 seconds.

4.5 Activating a programme



Once the programme has been defined, it can be activated as follows:

- Step 1:** Long press  3s to enter into timer functions
- Step 2:** Select the programme to be activated with the buttons  and .
- Step 3:** Keep pressing  until the ON/OFF indicator lights are displayed and start flashing.
- Step 4:** Press  to return to the main screen.



The ON/OFF lights indicate an active programme

4. Use

4.6 Forced de-icing function

Long  et  3 secondes to enter forced de-icing, the symbol  flashes.

4.7 Enable / Disable LEDs

Hold  and  for 3 seconds to activate or deactivate the front LEDs. The LEDs are reactivated automatically after a power cut.

4.7.2 Display in ° C or ° F

Hold  +  +  3 seconds to choose the display in ° C or ° F

4. Use

4.8 Download & Installation of the «Smart Life» application

About the Smart Life app:

You'll need to create a «Smart Life» account to control your heat pump remotely.

The «Smart Life» app lets you control your home appliances from anywhere. You can add and control multiple devices at once.

- Also compatible with Amazon Echo and Google Home (depending on the country).
- You can share your devices with other Smart Life accounts.
- Receive real-time operational alerts.
- Create scenarios with several devices, depending on the app's weather data (geolocation required).

For more information, go to the «Help» section of the «Smart Life» app

The «Smart Life» app and services are provided by Hangzhou Tuya Technology. Poolstar, owner and distributor of the Poolex brand, cannot be held responsible for the operation of the «Smart Life» app. Poolstar has no visibility on your «Smart Life» account.

iOS :

Search for «Smart Life» in the App Store to download the app:

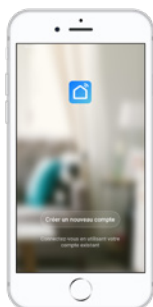

Check the compatibility of your phone and the version of your OS before installing the application

Android :

Search for «Smart Life» on Google Play to download the app :

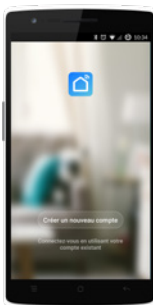

Check the compatibility of your phone and the version of your OS before installing the application

4. Use

4.9 Setting up the app

WARNING : Before you begin, make sure you have downloaded the «Smart Life» app, connected to your local WiFi network, and that your heat pump is electrically powered and running.

You'll need to create a «Smart Life» account to control your heat pump remotely. If you already have a Smart Life account, please log in and go directly to step 3.

Step 1 : Click on «Create new account» and choose to register by «Email» or «Phone,» where a verification code will be sent to you.

Enter your email address or phone number and click «Send verification code».

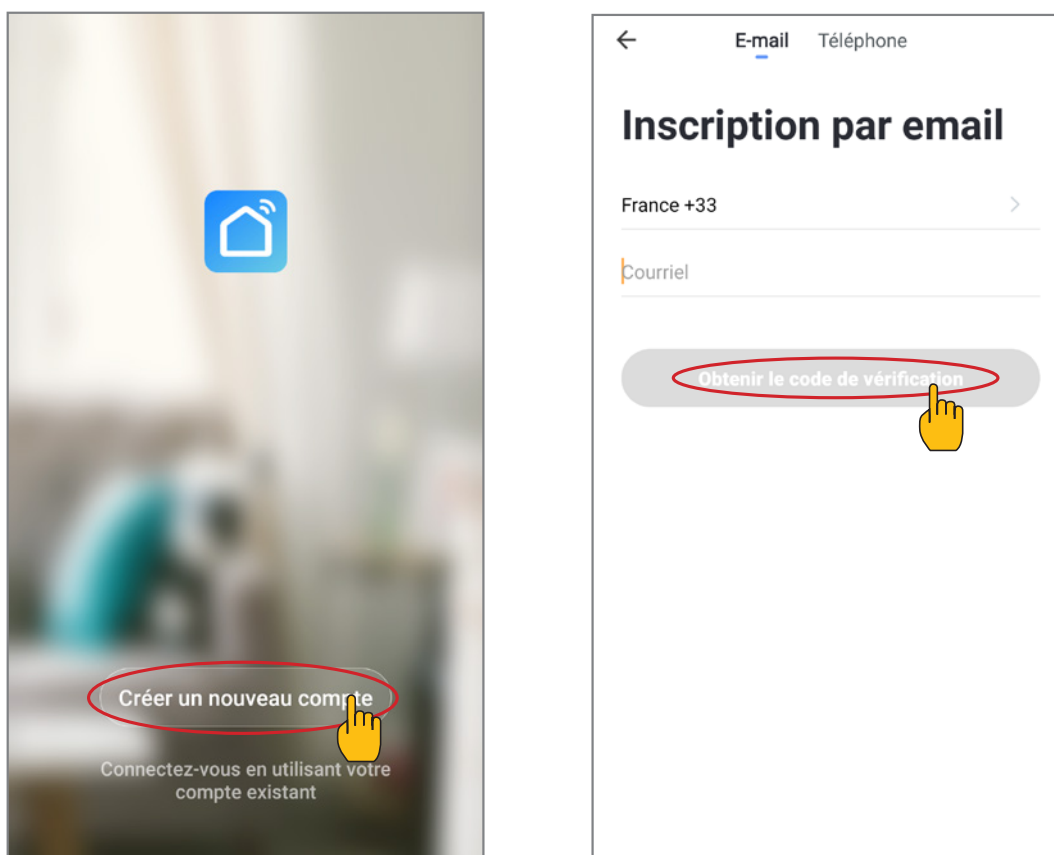

Step 2 : Enter the verification code received by email or phone to validate your account.

Congratulations! You are now part of the «Smart Life» community.

4. Use

Step 3 (Recommended): Add an object by clicking «...» and then «Add Object.» Enter its name («Pool» for example), then click «Done.»

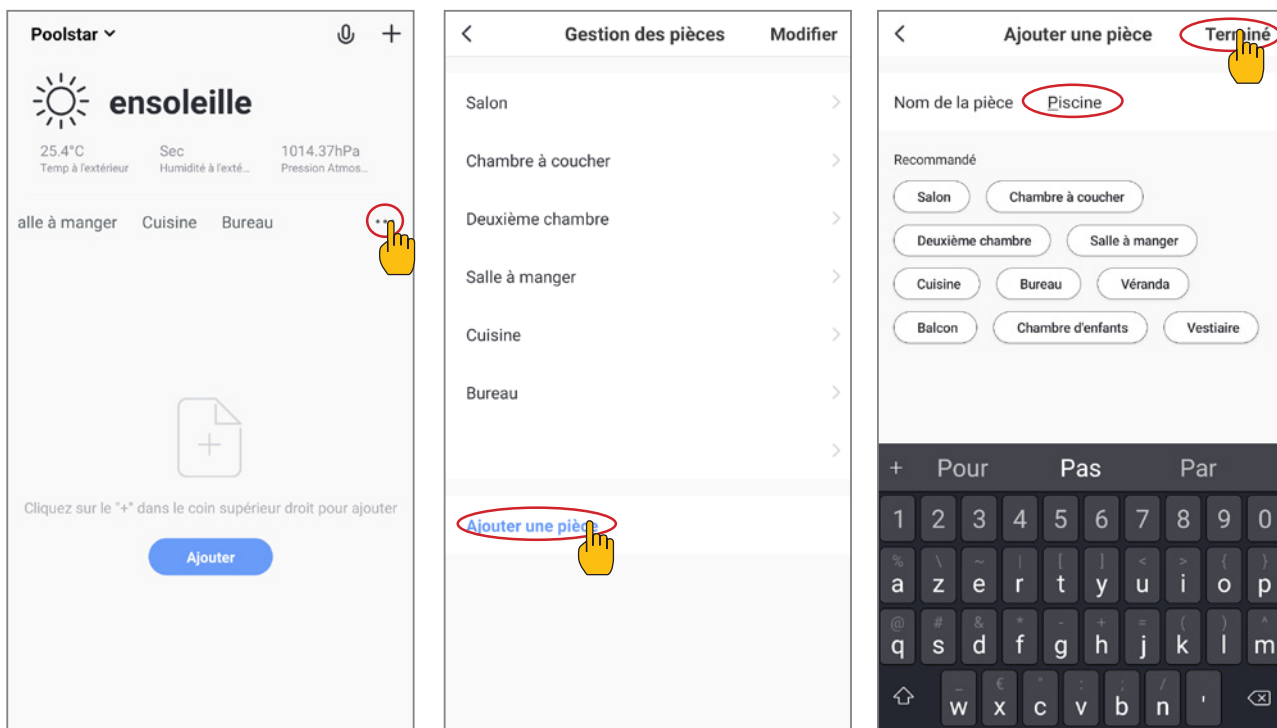

Step 4 : Now add a device to your «Pool»

Click «Add» or «+» and then «Large appliances...» followed by «Water heater.»

At this point, leave your smartphone on the «Add» screen and go to the pairing step for your control box.

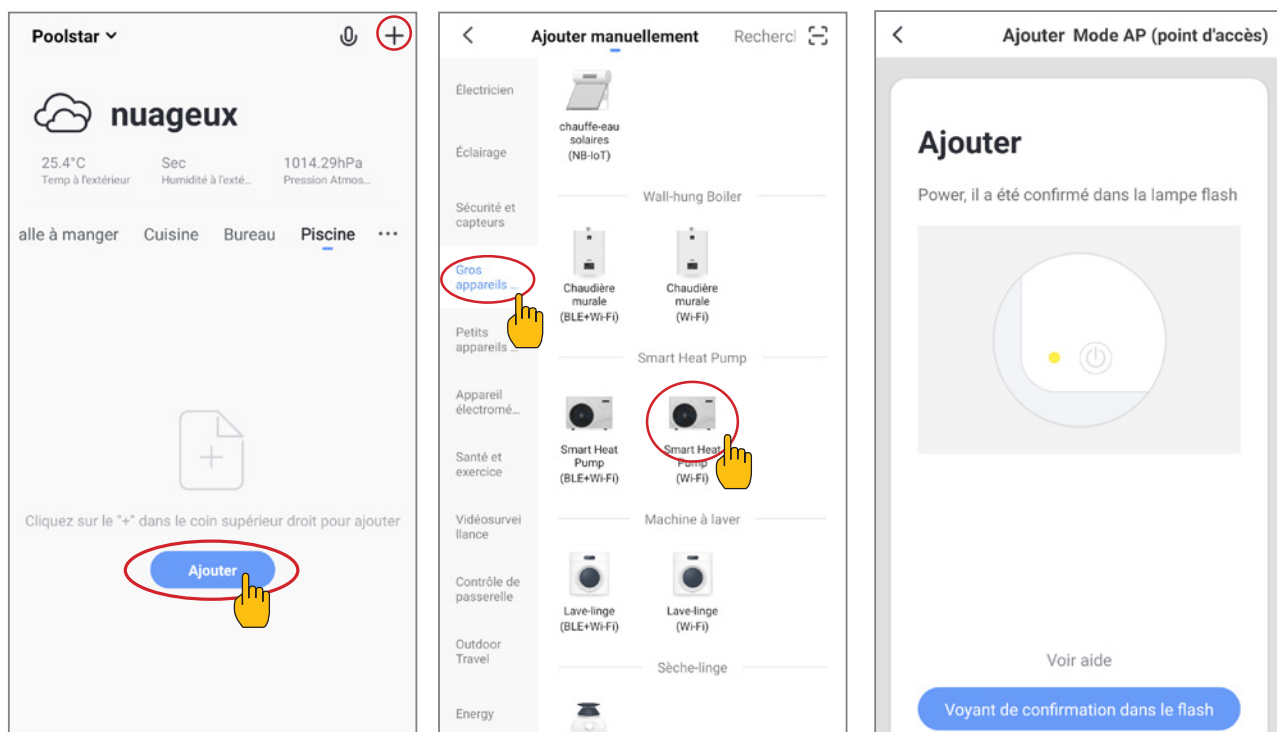

4. Use

4.10 Pairing the heat pump

4.10.1 EZ Mode

Step 1 : Now start the pairing.

Choose your home WiFi network, enter the WiFi password and press «Confirm».

Step 2 : Activate the pairing mode on your heat pump according to the following procedure:

The procedure depends on the model of your control box:



CAUTION The «Smart Life» application only supports 2.4GHz WiFi networks.

If your WiFi network uses the 5GHz frequency, go to the interface of your home WiFi network to create a second 2.4GHz WiFi network (available for most Internet boxes, routers and WiFi access points).

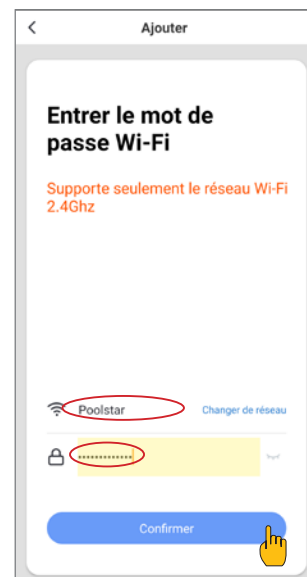

Press + simultaneously for 3s, flashes quickly, the control box is ready to be paired.

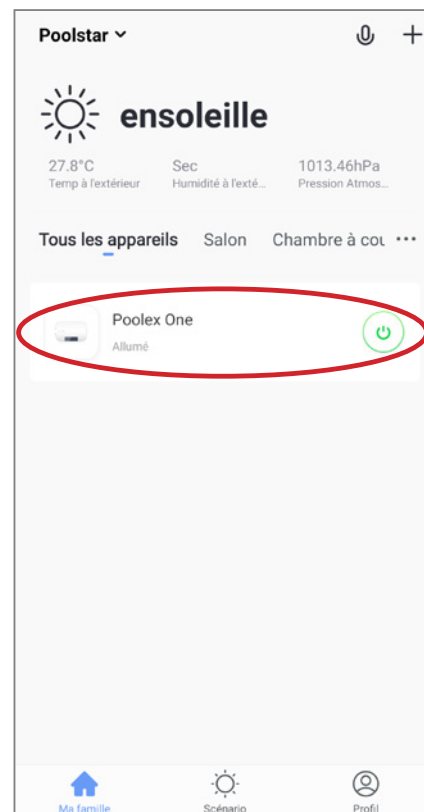
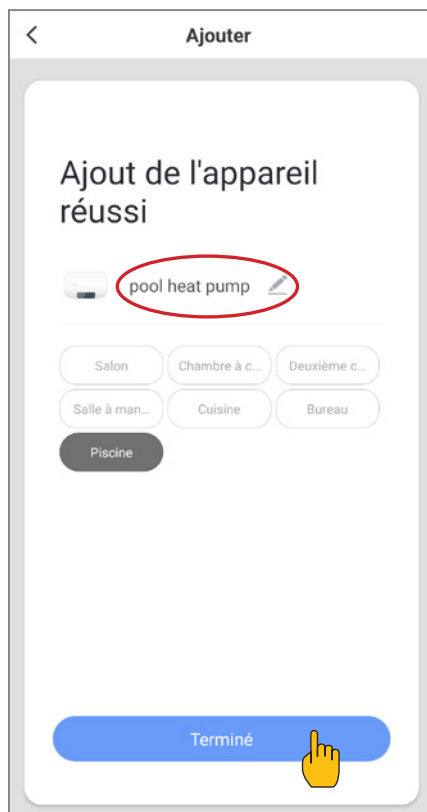

Note: The flashing stops when the box is connected to WiFi

4. Use

4.11 Controlling

Interface

- 1 Current pool temperature
- 2 Temperature setpoint
- 3 Current operating mode
- 4 Switch the heat pump on/off
- 5 Change the temperature
- 6 Change the operating mode
- 7 Set the operating range

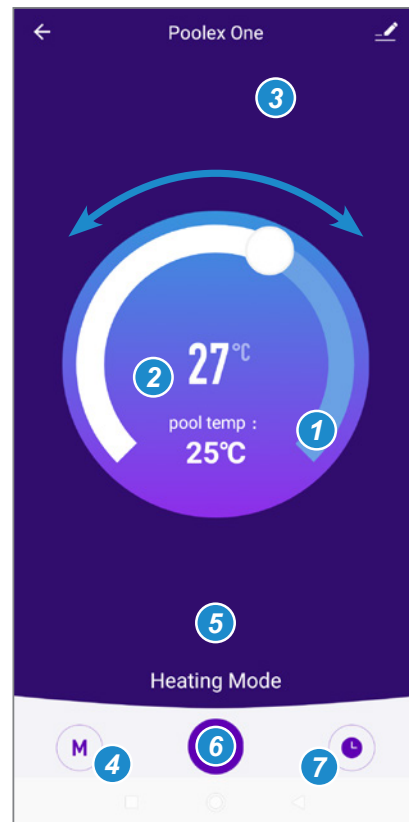

Configure the operating ranges for the heat pump

Step 1 : Create a schedule, choose the time, day(s) of the week(s), and the action (turn on or off) and save.

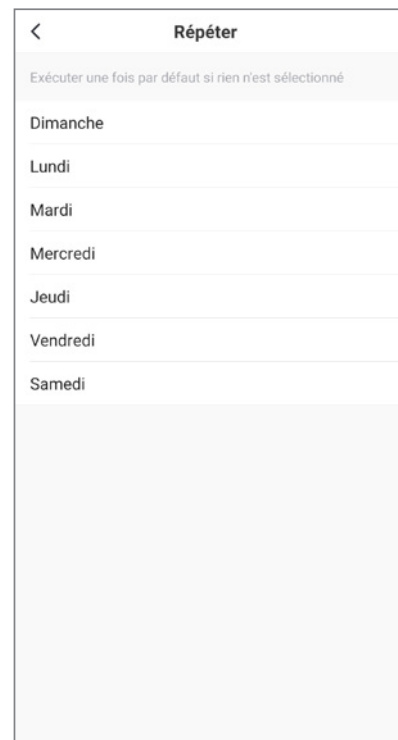
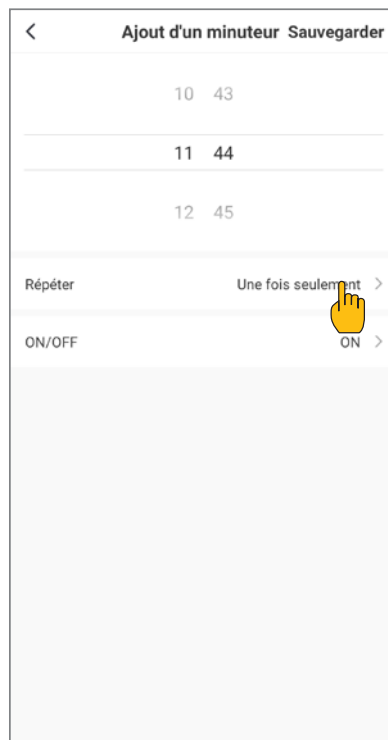
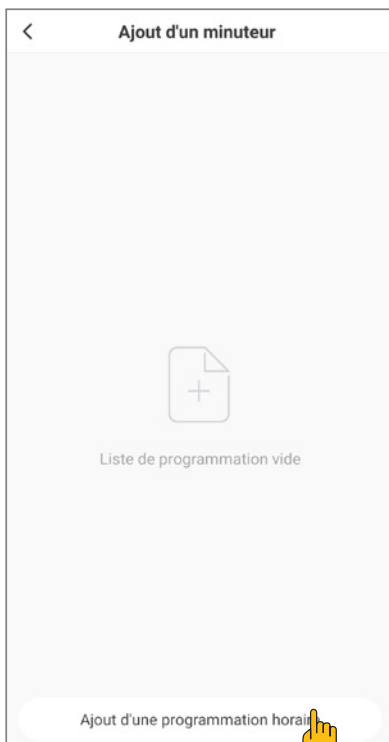

Step 2 : To delete a time slot, press on it and hold.

4. Use

Choice of operating modes

For Inverter heat pumps :
You can choose between Inverter Heating, Cooling,
Eco (Silent) or On/ Off (Manual) modes.



Available modes

- Inverter heating*
- Inverter cooling*
- On/Off (FIX)*
- Eco Inverter*

*Some modes may change depending on the machines

4. Use

4.12 Status values

The status values can be checked via the remote control by following these steps

Step 1: Keep pressing  until you enter the settings verification mode.

Step 2: Press  et  to check the status values.

Step 3: Press  to return to the main screen.

Status values table

N°	Description	Valeurs
01	Water inlet temperature	-30~99°C
02	Water outlet temperature	-30~99°C
03	Ambient temperature	-30~99°C
04	Discharge temperature	0~125°C
05	Suction temperatur	-30~99°C
06	Outside coil temperature	-30~99°C
07	Inside coil temperature	-30~99°C
08	The openness of the expansion valve	
09	Reserved	
10	Compressor current (A)	
11	PCB temperature (°C)	
12	Fan motor current (A)	
13	Compressor real frequency (Hz)	
14	Main PCB current (A)	
15	Fan motor speed (RPS)	0~2500, Real=display value*2

4. Use

4.13 System parameter query





WARNING : *This operation is used to assist servicing and future repairs.
The default settings should only be modified by an experienced professional person.*



WARNING : *Any change to the reserved settings will automatically void the warranty.*

The system's settings can be checked and adjusted via the remote control by following these steps

Step 1 : Keep pressing 3s on  until you enter the settings verification mode.

Step 2 : Press  and  for see the configured parameters.

Step 3 : Press  to select the setting to be modified, the value is blinking.

Step 4 : Press  and  to adjust the setting value.

Step 5 : Press  to set the new value.

Step 6 : Press  to return to the main screen.

If not opération for 10s, it will be exited automatically.

4. Use

Parameters table

N°	Description	Adjustment range	Factory setting	Remarks
01*	Adjustment of temperature difference before restart	1~18°C	1°C	Adjustable
02	Reserved - Do not adjust			Reserved
03	Reserved - Do not adjust			Reserved
04	Adjusting the cooling temperature	8~28°C	27°C	Adjustable
05	Adjusting the heating temperature	15~40°C	27°C	Adjustable
06	Reserved - Do not adjust			Reserved
07	Reserved - Do not adjust			Reserved
08	Reserved - Do not adjust			Reserved
09	Setting the compensation coefficient of the temperature water inlet	-5~15°C	0°C	Adjustable
10	Reserved - Do not adjust			Reserved
11	Auto-activation time before de-icing commences	20~90 min	45 min	Adjustable
12	De-icing activation temperature	-15~1°C	-3°C	Adjustable
13	Maximum de-icing duration	5~20 min	8 min	Adjustable
14	De-icing deactivation temperature	1~40°C	20°C	Adjustable
15	Reserved - Do not adjust			Reserved
16	Reserved - Do not adjust			Reserved
17	Expansive valve action period	20~90s	30s	Adjustable
18	Reserved - Do not adjust			Reserved
19	Reserved - Do not adjust			Reserved
20	Reserved - Do not adjust			Reserved
21	The mini opening for the electrical expansive valve	50~150	80	Adjustable
22	Reserved - Do not adjust			Reserved
23	Reserved - Do not adjust			Reserved
24	Reserved - Do not adjust			Reserved
25	Reserved - Do not adjust			Reserved
26	Reserved - Do not adjust			Reserved
27	Reserved - Do not adjust			Reserved
28**	Filtration pump servo-control mode	0 ~ 1	1	Adjustable
29	Max waterf outlet temp set in heating mode	25~40°C	40	Réglable

* **Parameter 01 allows you to change the lost degree interval from the requested temperature so that the heat pump starts again.**

Example : If the value of parameter 01 is 3°C, after reaching the required temperature (eg 27°C), the heat pump will restart when the pool temperature drops to 24°C (27 - 3).

** **Parameter 28: Control mode of the circulation pump**

When you switch on your heat pump, the circulation pump starts and then 1 minute later, the heat pump compressor is activated. When the heat pump stops running, its compressor and fan shut off, and after 30 seconds, the circulation pump stops. During a defrost cycle, the circulation pump will continue to operate regardless of the mode chosen.

Mode 1 : By selecting this mode, the heat pump will automatically put the circulating pump into continuous operation. Once the circulating pump is operating, the heat pump will start up 1 minute later. Next, when the required temperature is reached, the heat pump will stop working but will not stop the circulating pump, so as to ensure a constant circulation of water in your heat pump.

Mode 0 : This mode has been designed to maintain filtration in your pool without using the timetable programmer. When the required temperature is reached, the heat pump will go on standby, then 30 seconds later the circulating pump will shut down. The circulating pump will then be reactivated in special mode: 2 minutes operation, 15 minutes shut down, thus maintaining regular filtering of your pool. With a temperature sensor in the heat exchanger compartment, this mode allows your heat pump to update your pool's actual temperature every 15 minutes. We therefore recommend this mode. It is only when the pool temperature goes down by 3°C in relation to the required temperature that the filtration pump and the heat pump resume their normal operating mode. (This mode is recommended for a direct connection allowing a delayed start of the circulation pump and the heat pump without going through the timer the circulation pump).

5. Operation

5.1 Operation

Conditions of use

For the heat pump to operate normally, the ambient air temperature must be between -10°C and 43°C.

Recommendations prior to start-up

Before activating the heat pump, please:

- ✓ Check that the unit is firmly secured and stable.
- ✓ Check that the gauge indicates a pressure greater than 80 psi.
- ✓ Check that the electrical wiring is properly connected to the terminals.
- ✓ Check the earthing.
- ✓ Check that the hydraulic connections are tight and that there is no leakage of water.
- ✓ Check that the water is circulating correctly in the heat pump and that the flow rate is adequate.
- ✓ Remove any unnecessary object or tool from around the unit.

Operation

1. Activate the unit's power supply protection (differential switch and circuit-breaker).
2. Activate the circulating pump if it is not servo-controlled.
3. Check the By-Pass opening and the control valves.
4. Activate the heat pump.
5. Adjust the remote control clock.
6. Select the required temperature by using one of the remote control's mode.
7. The heat pump's compressor will start up after a few moments.

All you have to do now is wait until the required temperature is reached.



WARNING: Under normal conditions, a suitable heat pump can heat the water in a swimming pool by 1°C to 2°C per day. It is therefore quite normal to not feel any temperature difference in the system when the heat pump is working. A heated pool must be covered to avoid any loss of heat.

5.2 Servo-control of circulating pump

If you have connected a circulating pump to terminals P1 and P2, it is automatically electrically powered when the heat pump operates.

5. Operation

5.3 Using the pressure gauge

The gauge is for monitoring the pressure of the refrigerant contained in the heat pump. The values it indicates can vary considerably, depending on the climate, temperature and atmospheric pressure.

When the heat pump is in operation:

The gauge's needle indicates the refrigerant pressure.

Mean operating range between 250 and 450 PSI, depending on the ambient temperature and atmospheric pressure.

When the heat pump is shut down:

The needle indicates the same value as the ambient temperature (within a few degrees) and the corresponding atmospheric pressure (between 150 and 350 PSI maximum).

If left unused for a long period of time :

Check the pressure gauge before starting up the heat pump. It must indicate at least 80 PSI.

If the pressure goes down too much, the heat pump will display an error message and automatically go into 'safe' mode.

This means that there has been a leakage of refrigerant and that you must call a qualified technician to replace it.

5.4 Antifreeze protection



WARNING: For the antifreeze system to work, the heat pump must be powered and the circulating pump activated. If the circulating pump is servo-controlled by the heat pump, it will be automatically activated.

When the heat pump is on standby, the system monitors the ambient temperature and the water temperature in order to activate the antifreeze programme if required.

The antifreeze programme is automatically activated when the ambient temperature or the temperature of the water is less than 2°C and when the heat pump has been shut down for more than 120 minutes.

When the antifreeze programme is running, the heat pump activates its compressor and the circulating pump so as to reheat the water until the water temperature exceeds 2°C.

The heat pump automatically leaves the antifreeze mode when the ambient temperature is greater than or equal to 2°C or when the heat pump is activated by the user.

6. Maintenance and servicing

6.1 Maintenance and servicing



WARNING: Before undertaking maintenance work on the unit, ensure that you have disconnected the electrical power supply.

Cleaning

The heat pump's casing must be cleaned with a damp cloth. The use of detergents or other household products could damage the surface of the casing and affect its properties.

The evaporator at the rear of the heat pump must be carefully cleaned with a vacuum cleaner and soft brush attachment.

Annual maintenance

The following operations must be undertaken by a qualified person at least once a year.

- ✓ Carry out safety checks.
- ✓ Check the integrity of the electrical wiring.
- ✓ Check the earthing connections.
- ✓ Monitor the state of the pressure gauge and the presence of refrigerant.

6.2 Winter storage

In the winter months when the ambient temperature is lower than 3°C, a shut-down heat pump must be winterised to avoid any frost damage.

Winterising in 4 steps



Step 1
Disconnect the heat pump from the power supply.

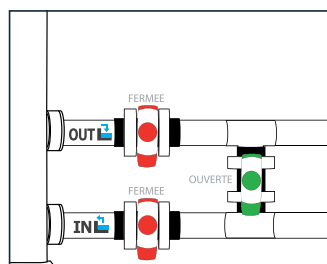

Step 2
Open the By-Pass valve. Close the inlet and outlet valves.

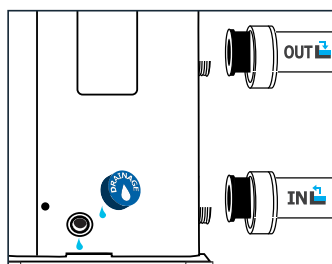

Step 3
Unscrew the drain plug and water pipes in order to drain any water from the heat pump.

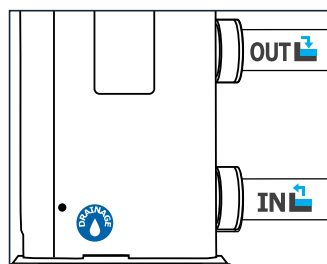

Step 4
Screw back the drain plug and pipes or block them with rags so as to prevent any foreign bodies from getting into the circuit. Finally, protect the pump with its winter storage cover.



If a circulating pump is servo-controlled by the heat pump, drain this also.

7. Repairs



WARNING: Under normal conditions, a suitable heat pump can heat the water in a swimming pool by 1°C to 2°C per day. It is therefore quite normal to not feel any temperature difference in the system when the heat pump is working.

A heated pool must be covered to avoid any loss of heat.

7.1 Breakdowns and faults

In the event of a problem, the heat pump's screen displays a fault symbol **ERROR** instead of temperature indications. Please consult the table opposite to find the possible causes of a fault and the actions to be taken.

Fault code examples:

Fault code E05



7. Repairs

7.2 List of faults

Code	Fault	Possible causes	Action
03	Flow sensor malfunction	Insufficient water in heat exchanger	Check your water circuit operation and the opening of the By-Pass valves
		Sensor disconnected or defective	Reconnect or replace sensor
04	Antifreeze protection	Protection activated when the ambient temperature is too low and the unit is on standby	No intervention is necessary
05	High pressure protection	Insufficient water flow	Check water pump operation and openings of By-Pass inlet/outlet valves
		Excess refrigerant gas	Readjust the refrigerant volume
		Defective 4-way valve	Replace the 4-way valve
		High pressure switch disconnected or defective	Reconnect or replace high pressure switch
06	Low pressure protection	Insufficient refrigerant gas	Readjust the refrigerant volume
		Defective 4-way valve	Replace valve
		Low pressure switch disconnected or defective	Reconnect or replace low pressure switch
09	Connection problem between PCB and wired remote control	Bad connection	Check wiring connections between remote control and PCB
		Defective wired remote control	Replace remote control
		Defective PCB	Replace PCB
10	Connection problem between PCB and inverter module	Bad connection	Check wiring connections between PCB and inverter module
		Defective inverter module	Replace inverter module
		Defective PCB	Replace PCB
12	Vented air temperature too high	Insufficient refrigerant gas	Readjust the refrigerant volume
13	Vented air temperature too low	Ambiant temperature too low	Vérifiez la température ambiante
		Sensor disconnected or defective	Reconnect or replace sensor
15	Water intake temperature sensor malfunction	Sensor disconnected or defective	Reconnect or replace sensor
16	Outside coil temperature error	Sensor disconnected or defective	Reconnect or replace sensor
18	Vented temperature error	Sensor disconnected or defective	Reconnect or replace sensor
20	Inverter module protection	See chapter Appendices	
21	Ambient temperature error	Sensor disconnected or defective	Reconnect or replace sensor
23	Water temperature at outlet too low for cooling mode	Insufficient water flow	Check water pump operation and openings of By-Pass inlet/outlet valves
27	Water outlet error	Sensor disconnected or defective	Reconnect or replace sensor
29	Backed temperature error	Sensor disconnected or defective	Reconnect or replace sensor
32	Outlet temperature too high for heating mode protection	Insufficient water flow	Check water pump operation and openings of By-Pass inlet/outlet valves
33	Coil temp too high (higher than 60°C) for cooling mode protection	Refrigerant overcharged	Readjust the refrigerant volume
		Fan motor doesn't work or air outlet blocked	Check the fan is working properly and the air inlet is unobstructed
34	Too great a difference between the inlet water temperature and the outlet water temperature	Insufficient water flow	Check the good circulation of water in the heat pump, and the opening of the inlet / outlet valves of the By Pass
		Sensor disconnected or defective	Reconnect or replace sensor
42	Inside coil temperature error	Sensor disconnected or defective	Reconnect or replace sensor
46	DC fan motor malfunction	Bad wire connection	Reconnect the fan
		Fan motor is defective	Replace the fan motor

8. Recycling

8.1 Recycling the heat pump

Your heat pump has reached the end of its life and you wish to dispose of it or to replace it. Do not throw it in the rubbish bin.

A heat pump must be disposed of separately with a view to its reuse, recycling or upgrading. It contains substances that are potentially hazardous to the environment but which will be eliminated or neutralised by recycling.

YOU HAVE THREE SOLUTIONS:

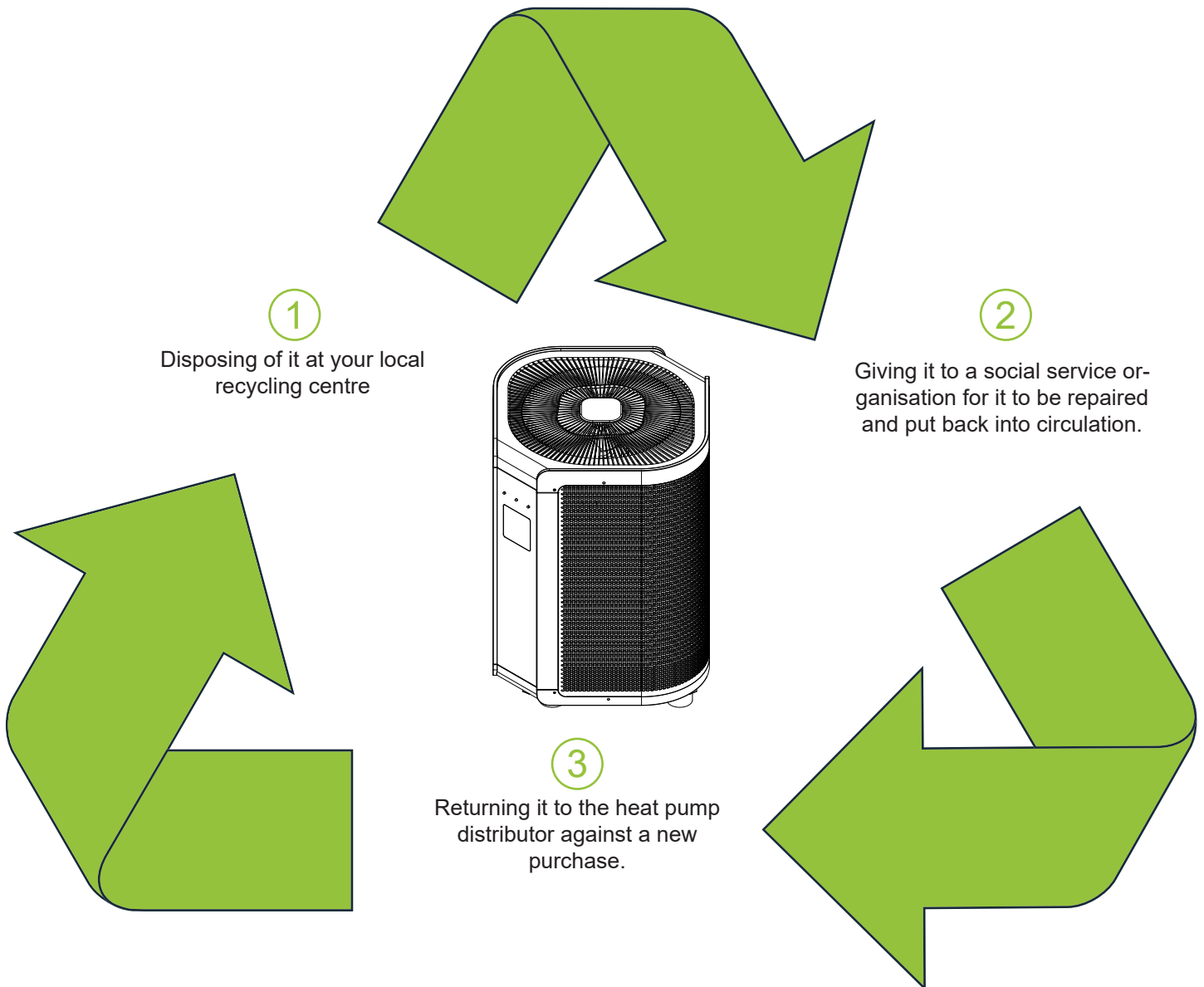

9. Warranty

9.1 General warranty conditions

The Poolstar Company guarantees the original owner against defective materials and faults in the manufacture of the Poolex Vertigo Fi heat pump for a period of three (3) years.

The compressor is guaranteed for a period of five (5) years.

The titanium tube heat exchanger is guaranteed for a period of fifteen (15) years against chemical corrosion, except for frost damage.

The condenser's other components are guaranteed for three (3) years.

The warranty becomes effective on the date of the first invoice.

The warranty does not apply in the following cases:

- Malfunction or damage arising from an installation, usage or repair that is not in compliance with the safety instructions.
- Malfunction or damage arising from a chemical agent that is unsuitable for the pool.
- Malfunction or damage arising from conditions that are unsuitable for the equipment's purposes of use.
- Damage arising from negligence, accident or force majeure.
- Malfunction or damage arising from the use of unauthorised accessories.

Repairs undertaken during the warranty period must be approved prior to being carried out by an authorised technician. The warranty shall be null and void if the repair to the equipment is carried out by a person who is not authorised by the Poolstar company.

The guaranteed parts shall be replaced or repaired at Poolstar's discretion. Defective parts must be returned to our workshops to be covered during the warranty period. The warranty does not cover labour costs or unauthorised replacements. The return of the defective part is not covered by the warranty.

Dear Sir/Madam,

**Please spend a few minutes filling in the warranty registration card
that you will find on our website:**

<http://support.poolex.fr/>

We thank you for your trust in our products.
Enjoy your swimming!

Your details may be treated in accordance with the Data Protection Act of
6 January 1978 and will not be divulged to any third party.

10. Appendices

10.1 Wiring diagrams

Vertigo Fi 55

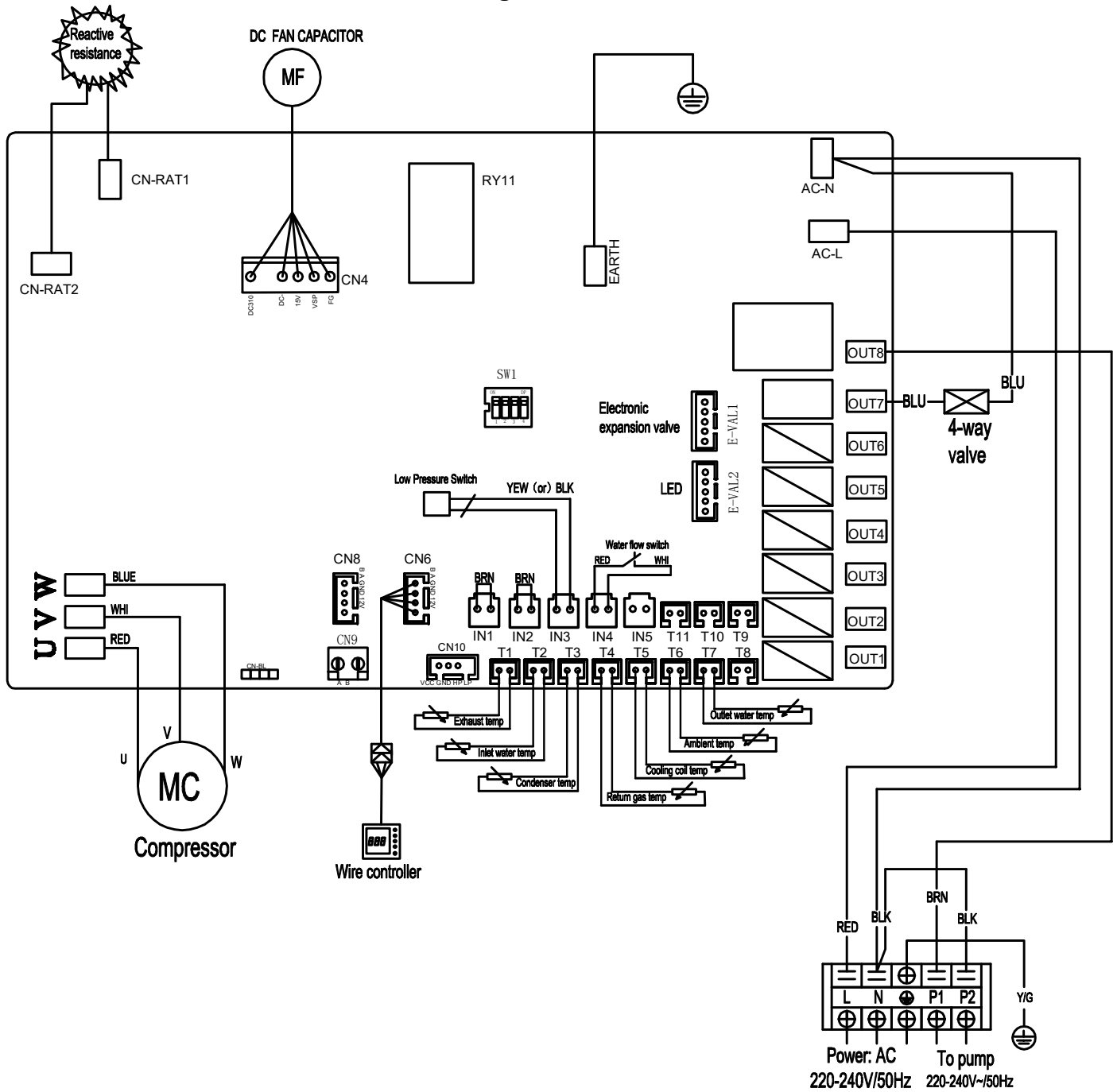

10. Appendices

Vertigo 75 / 95 / 125

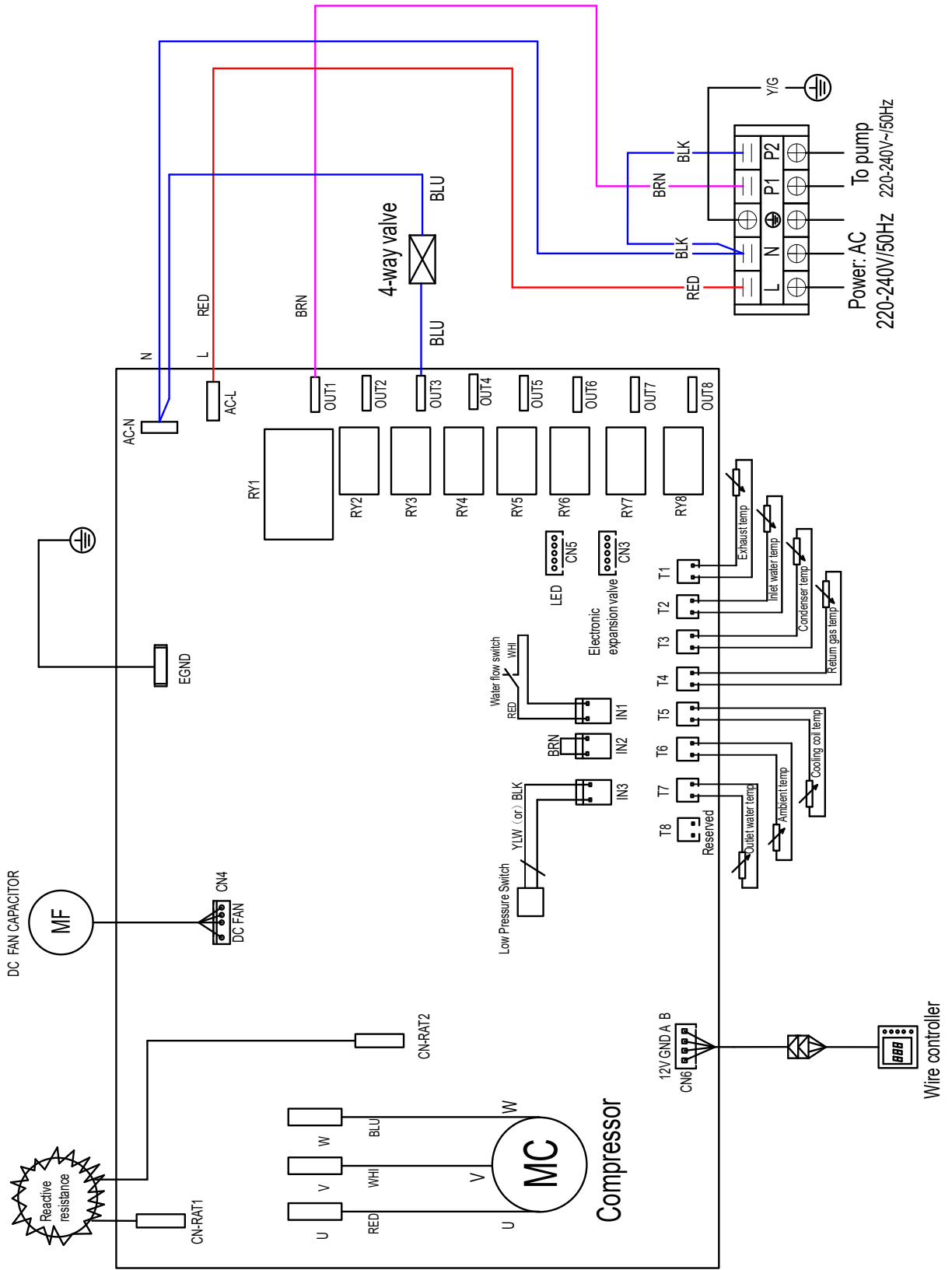

10. Appendices

Vertigo 155

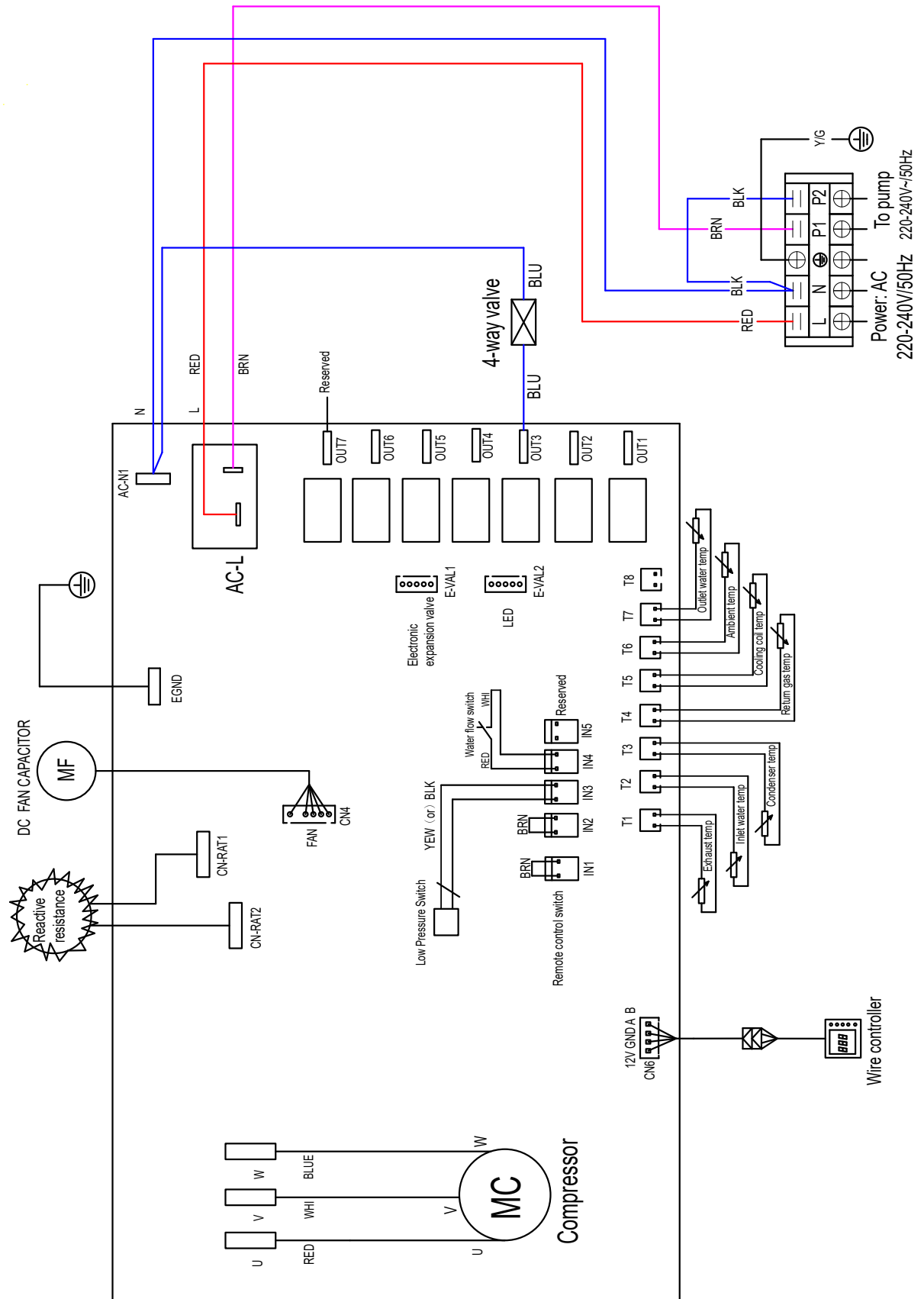

10. Appendices

Vertigo 200

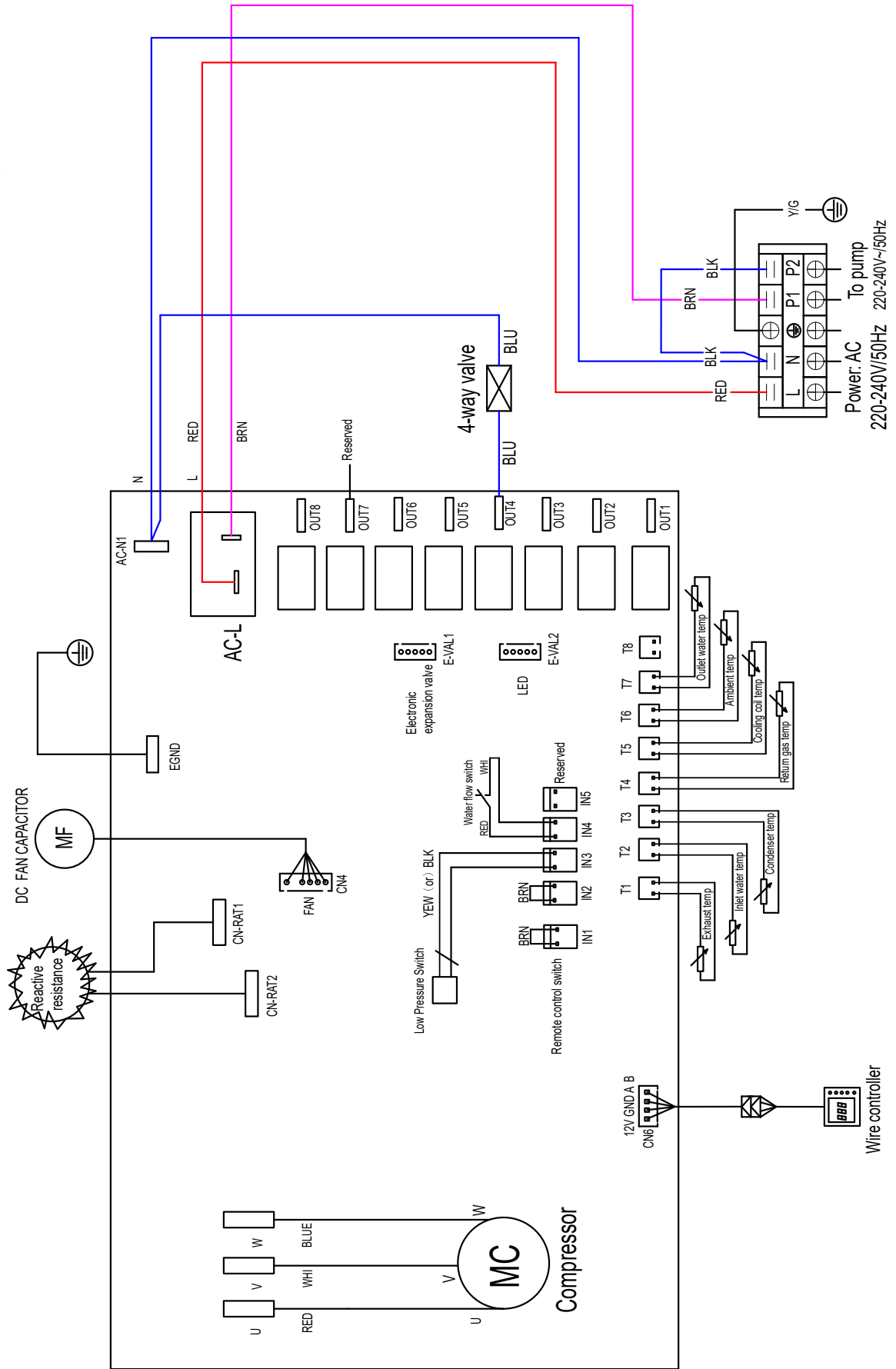

10. Appendices

Vertigo 240

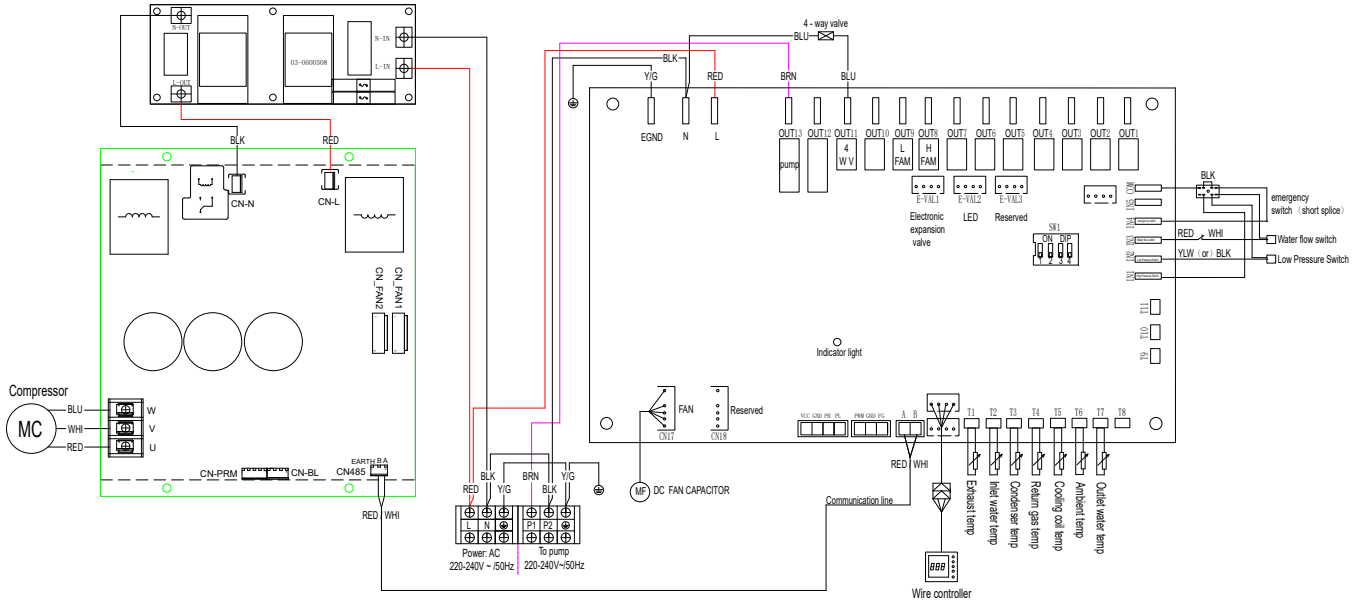

Vertigo 155T / 200T / 240T / 300T / 350T

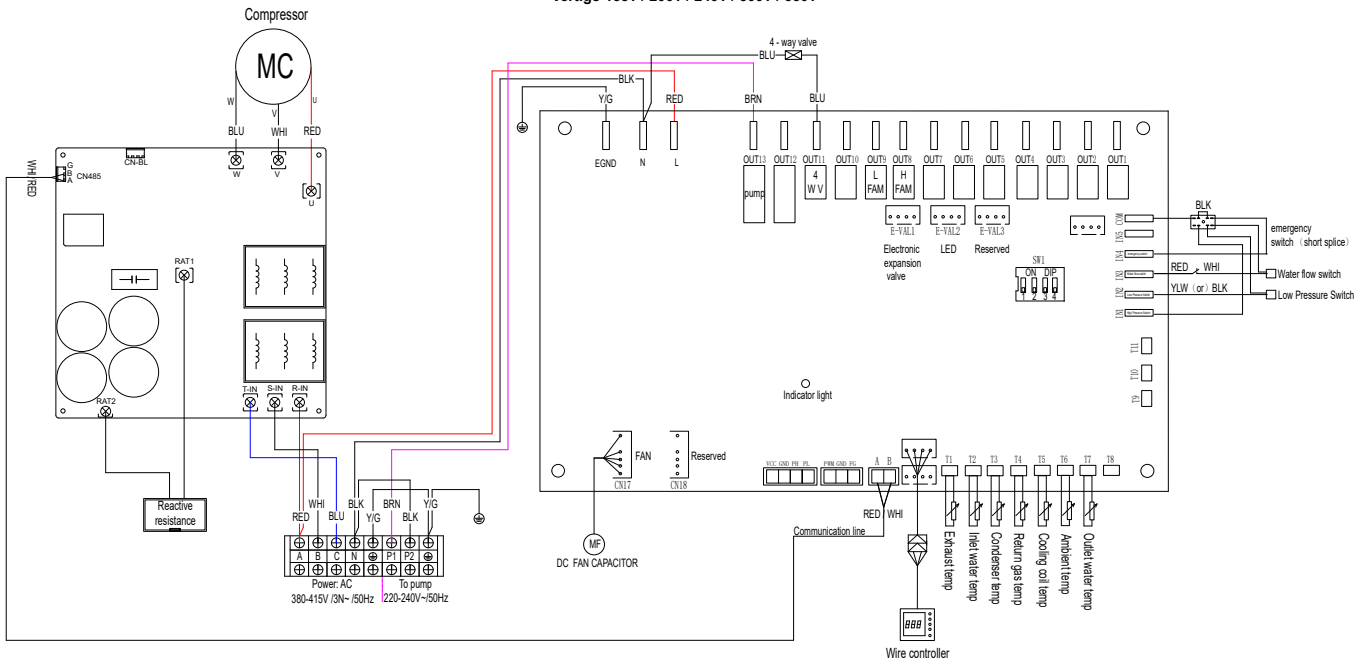

10. Appendices

10.2 Error E20 complement

Code	Anomalies	Causes possibles	Actions
1	IPM excessive current	IPM module failure	Replace the inverter module
2	Compressor failure	Compressor failure	Replace the compressor
4	Reserved	--	--
8	Compressor lack of phase	The wire for the compressor break/bad connection	Check the wire connection of the compressor
16	DC bus voltage too low	Input voltage too low/PFC module failure	Check input voltage/replace module
32	DC bus voltage too high	Input voltage too high/PFC module failure	Replace the inverter module
64	Temp of radiating fin too high	Fan motor failure/Air duct blockage	Check fan motor/air duct
128	Temp of radiating fin failure	Radiating fin temp sensor short circuit or open circuit failure	Replace the inverter module
257	Connection failure	Inverter module doesn't receive the command of PCB	Check the connection between the module and PCB
258	AC input lack of phase	Input lack of phase	Check the wire connection
260	AC input voltage to high	Input three-phase unbalance	Check input the 3-phase voltage
264	AC input voltage too low	Input voltage too low	Check input voltage
272	High pressure failure	Compressor pressure too high (reserved)	--
288	IPM temp too high	Fan motor failure/Air duct blockage	Check fan motor/air duct
320	Compressor current too high	The current of the compressor wiring too high/ Driver and compressor do not match	Replace the inverter module
384	Reserved	--	--

POOLEX

 RoHS CE

TECHNICAL ASSISTANCE

www.poolex.fr